



## Table of Contents

<b>WELCOME.....</b>	<b>4</b>
Safety Summary .....	4
RECAPITULATIF DES MESURES DE SECURITE.....	5
About the GLS Documentation.....	6
Product Description.....	7
Identifying GLS Components .....	8
Compatible Equipment.....	9
Typical Applications .....	9
Technical Specifications.....	10
Radio Interference Statement .....	10
CE Declaration of Conformity.....	10
Warranty .....	10
About Isco.....	11
<b>PREPARING THE GLS .....</b>	<b>12</b>
Inspecting the Pump Tube .....	13
Discharge Tube.....	14
Installing a Bottle.....	15
Sample Cooling .....	15
Installing a Power Source .....	16
The Suction Line and Strainer.....	17
Cutting the Suction Line.....	17
Attaching the Strainer.....	18
Connecting the Suction Line .....	19
Connecting External Devices .....	20
Positioning the GLS .....	21
Locking the GLS .....	22

<b>PROGRAMMING .....</b>	<b>23</b>
Introduction to GLS Programming.....	23
GLS Interface.....	23
The GLS Interface.....	23
The GLS Display.....	24
The GLS Keypad .....	24
GLS Operating States.....	25
Programming .....	26
Programming the GLS .....	26
One-button Programming.....	27
One-button Programming.....	27
Stored Program.....	27
Standard Programming .....	28
Standard Programming .....	28
Sample Pacing.....	29
Pacing Interval.....	29
Bottle Volume .....	30
Number of Samples.....	31
Sample Volume.....	32
Delay to First Sample .....	33
Suction Line.....	34
Setting the Time and Date.....	35
<b>CALIBRATING SAMPLE VOLUMES .....</b>	<b>36</b>
Calibration Step 1 .....	37
Calibration Step 2 .....	37
Calibration Step 3 .....	38
Calibration Step 4 .....	38
Calibration Step 5 .....	39
Calibration Step 6 .....	40
<b>RUNNING A PROGRAM .....</b>	<b>41</b>
Starting a Program.....	41
Counting Down Delay Times.....	41
Sampler Inhibit.....	42
Run State Displays .....	43
Sample Collection Cycle .....	44
Pausing or Stopping a Program .....	45
Program Completion .....	45
Post-sampling Activities .....	45
Recovering the Sampler.....	46
Preparing the Full Sample Bottle.....	46
Log.....	47
Errors.....	48
<b>GRAB SAMPLES .....</b>	<b>49</b>

<b>SERVICING THE SAMPLER.....</b>	<b>50</b>
Routine maintenance .....	51
Cleaning .....	51
Cleaning the GLS.....	51
Cleaning the Bottles .....	51
Cleaning the Suction Line and Tubing .....	51
Cleaning Protocols for Priority Pollutants.....	52
Replacing the Pump Tube.....	53
Replacing the Discharge Tube .....	55
Servicing Batteries and Power Packs .....	55
Preventive maintenance.....	56
Replacing the Internal Desiccant.....	56
Renewing the Desiccant.....	58
Diagnostics and Repair .....	59
GLS Self-diagnostics.....	59
Contacting Isco for Assistance .....	60
Return Instructions .....	61
Replacement Parts.....	61
Schematic and Board Layout .....	62
<b>GLS OPTIONS.....</b>	<b>63</b>
Storing a Program.....	63
Liquid Detector Disable .....	63
Program Lock .....	65
Foreign Language Displays .....	67
Software Updates .....	68
Accessories .....	69
Pressurized lines.....	71

# Welcome

Welcome to the GLS manual and thank you for your purchase of the Isco GLS automated wastewater sampler.

## Safety Summary

The Isco GLS Portable Sampler is a “definite purpose” device, intended for use only with compatible Isco equipment. Do not use this product with any other manufacturers’ equipment, or for any other purpose. Use for any purpose not described in this manual could cause personal injury or property damage.

### Electrical Requirements

The GLS requires 12 V  $\overline{\text{---}}$  at 3.75 amperes. The input is through the two-pin military type connector on the side of the controller. An internal 3.75 ampere PTC (Positive Temperature Coefficient) protects the internal circuitry.

### Safety Symbols and Hazard Alerts

The icons found within this instruction manual alert the user of known hazards. The icons are described below.



This icon identifies a general hazard. Refer to the instruction manual for more information.

The instruction manual identifies the hazardous condition and any steps necessary to correct the condition. The manual presents this information in one of two ways:



Cautions identify a potential hazard, which if not avoided, may result in minor or moderate injury. This category can also warn you of unsafe practices, or conditions that may cause property damage.



Warnings identify a potentially hazardous condition, which if not avoided, could result in death or serious injury.

## RECAPITULATIF DES MESURES DE SECURITE

L'échantillonneur modèle GLS est un appareil "à but défini", qui doit être utilisé uniquement avec du matériel compatible Isco. Ne pas utiliser ce produit avec le matériel d'autres fabricants ou à d'autres fins. Son usage à d'autres fins que celles indiquées dans ce manuel pourrait provoquer des accidents corporels ou des dégâts matériels.

### Conditions électriques requises

L'alimentation du GLS est 12 V  $\overline{\text{---}}$  à 3,75 ampères. Un connecteur à deux bornes du type militaire à la fin du fil fournit ce courant d'un accumulateur ou d'un transformateur-chargeur. Un disjoncteur special «fusible plastique» du type «PTC» (coefficient positif de la température) de 3,75 ampères protège les circuits du contrôleur. Ce disjoncteur se trouve à l'intérieur du contrôleur et se remet en marche automatiquement.

### Symboles de securite et signaux de danger

Les icônes placées sur l'échantillonneur modèle «GLS» ainsi que celles trouvées dans ce manuel d'instructions avertissent l'utilisateur des dangers connus. Ces icônes sont définies ci-dessous.



Cette icône représente un danger d'ordre général. Consultez le manuel d'instructions pour de plus amples informations.

Le manuel d'instructions décrit chaque situation dangereuse ainsi que les mesures à prendre pour la rectifier. Le manuel présente ces renseignements de deux façons:



"Avis" indique un danger potentiel qui, s'il n'est pas évité, pourrait provoquer des blessures plus ou moins graves. Cette catégorie sert également à informer l'utilisateur des actions ou conditions qui pourraient provoquer des dégâts matériels.



"Avertissement" indique la présence de circonstances qui pourraient être très dangereuses pouvant, si elles ne sont pas évitées, provoquer des blessures graves ou même la mort.

## About the GLS Documentation

The primary source of the documentation is in a Windows Help file on the GLS compact disc. This file contains complete documentation to operate and maintain the GLS sampler. There are several supporting documents in a Portable Document Format (PDF) that are linked to this file. The supporting documents, such as the warranty, require Adobe's Acrobat Reader for viewing.

If your computer does not have an Acrobat Reader installed, please install it from "AcroInst" folder on the compact disc. Double-click on "Ar32e301.exe" and follow the instructions. Acrobat Reader may be installed and used free of charge provided you comply with the license agreement. This GLS CD contains the 32-bit Windows version, suitable for use on Windows 95, 98, NT 3.51, and NT 4.0 operating systems. Once installed, the Acrobat Reader requires about 6 MB of storage space.

In addition to the files on the compact disc, the GLS Pocket Guide contains condensed operating instructions. When you are in the field, the printed pocket guide makes a handy reference.

The compact disc's "Extras" folder includes other instruction manuals from Isco.

**Note:**

To print a complete manual from the Windows Help file, click on the "Help Topics" button and select the "Contents" tab. Highlight a book and click on the "Print" button. Repeat this step for each book.

You may also print this .PDF file for a "hard-copy" manual.

## **Product Description**

The GLS is a compact portable sampler that is ideal in applications where full-sized automated sampling is not practical. The small size and weight make the sampler easy to handle and transport from site to site. The GLS was designed for easy insertion and removal from manholes as small as 18 inches (457 mm) in diameter.

The GLS collects liquid samples and places them in a composite sample container. The largest sample containers will hold 2.5 gallons (10 liters). A dependable peristaltic pump delivers the liquid to the bottle. Its pump, coupled with the non-contacting liquid detector, gives you accurate, repeatable sample volumes time after time. The liquid detector is also used to halt the sampling routine when a full bottle is detected.

At the heart of the sampler is the GLS controller. It is environmentally sealed (rated NEMA 4X, 6 and IP67) to provide protection from accidental submersion and long term exposure to high humidity and corrosive gases. Its tactile keypad and 2 line, 20 character display simplifies operation. In just seconds, the one-button programming procedure will load the stored program settings and run the sampling routine.

## Identifying GLS Components

Major GLS components are depicted below.

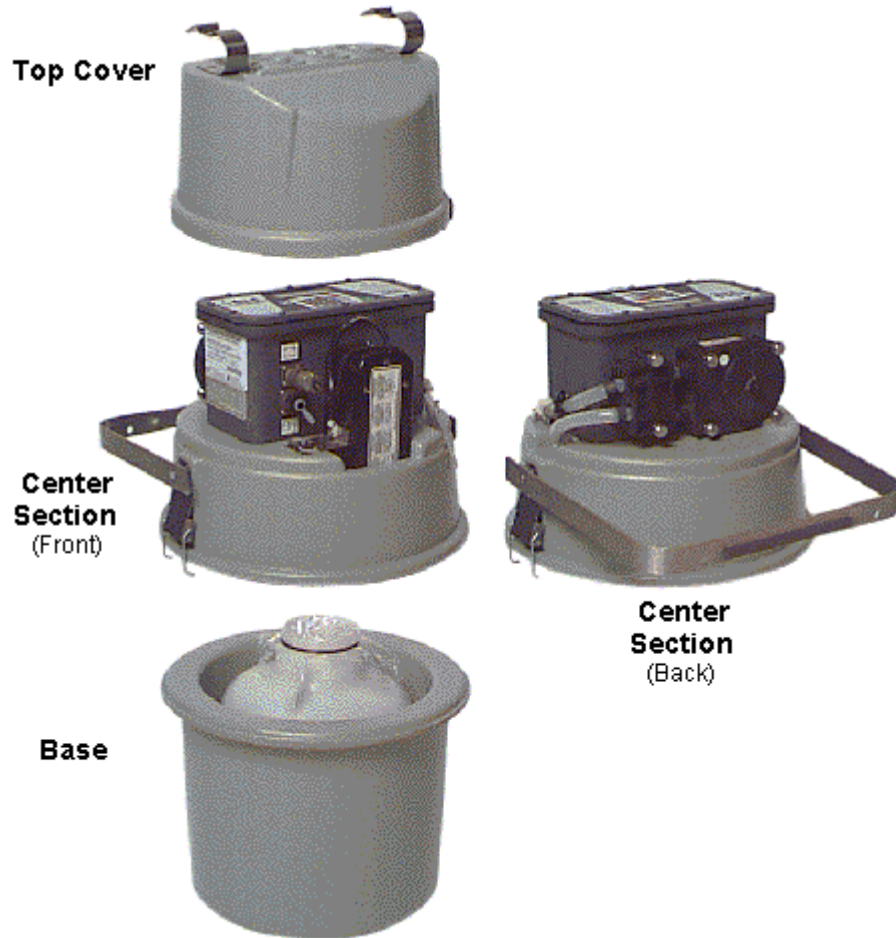



## **Compatible Equipment**

Compatible Isco devices include:

Isco flow measuring instruments:

- 4100 Series Flow Loggers
- 4200 Series Flow Meters

Non-Isco device interfaces:

- 4-20 mA Input Interface
- Pulse Duration Input Interface

Isco parameter measuring instruments:

- PAL 1101 pH and Temperature Actuator/Logger
- Liquid Level Actuator

## **Typical Applications**

The GLS is designed to meet the needs of general purpose or priority pollutant sampling in municipal and industrial applications.

The GLS is part of Isco's many automated sampling solutions which include the Model 3700 and 6700 Series samplers. This versatile product line meets the demands of:

- NPDES permit compliance
- Pre-treatment compliance
- Stormwater run-off
- Combined sewer overflow
- Sanitary sewer evaluations
- Non-point source sampling
- Biomonitoring

## Technical Specifications

Technical specifications are listed on the Isco Product Data Sheet.

[Product Data Sheet](#)

## Radio Interference Statement

### FCC Warning

**Changes or modifications to this unit not expressly approved by the party responsible for compliance could void the user's authority to operate the equipment.**

### Note:

This equipment has been tested and found to comply with the limits for a Class A digital device, pursuant to Part 15 of the FCC's rules. These limits are designed to provide reasonable protection against harmful interference when the equipment is operated in a commercial environment. This equipment generates, uses, and can radiate radio frequency energy and, if not installed and used in accordance with the instructions, may cause harmful interference to radio communications. Operation of this equipment in a residential area is likely to cause harmful interference in which case the user will be required to correct the interference at his own expense.

### Canada

This ISM apparatus meets all requirements of the Canadian Interference-Causing Equipment Regulations.

Ce générateur de fréquence radio ISM respecte toutes les exigences du Règlement sur le matériel brouilleur du Canada.

## CE Declaration of Conformity

Isco, Inc. has issued a CE Declaration of Conformity for the GLS Sampler.

[CE Declaration of Conformity](#)

## Warranty

The GLS is covered by a limited one-year warranty.

[Isco One-year Warranty](#)

## About Isco

Isco, Inc., is a designer, manufacturer, and worldwide marketer of instruments used by engineers, technicians, and scientists in the field and laboratory to address concerns such as water pollution, process monitoring and quality control, environmental testing, and research and development in chemistry and biotechnology.

Isco, founded in 1958 and headquartered in Lincoln, Nebraska, USA, is a publicly owned company traded on the NASDAQ/NMS under the symbol ISKO.

### Isco Product Lines

**Environmental Water Monitoring Products** are the tools of choice for municipal, industrial, and regulatory professionals responsible for monitoring the quality and quantity of wastewater and surface water. Isco Environmental products include automatic portable and refrigerated samplers, flow meters, and parameter monitoring instruments.

- Automatic samplers for water and wastewater
- Open-channel flow meters
- UniMag closed-pipe magnetic flow meters
- Pump Station monitor for measuring flow and monitoring performance

**Process Monitoring Products** include on-line analyzers used for measuring total organic carbon (TOC) in aqueous flow streams. Continuous on-line monitoring of TOC provides improved process control in applications ranging from drinking water to industrial and municipal wastewater treatment.



**Liquid Chromatography Products** include high- and low-pressure chromatography systems for protein purification, for isolating synthetic organic compounds, and for general preparative and analytical HPLC. Isco fraction collectors handle applications from routine LC to programmable automation of complex liquid-handling protocols.

**Syringe Pumps Products** are utilized to deliver fluids precisely and accurately at high pressures. They are primarily used for precision fluid metering in the plastics and petroleum industries.

**Supercritical Fluid Extraction Products** (SFE) is an analytical extraction and sample preparation method used in research and process support labs. Isco-Suprex SFE systems provide fast, clean, automated extraction of target analytes from a wide variety of samples, using carbon dioxide instead of hazardous organic solvents.

## Preparing the GLS

The following checklist can be used as a guide to prepare the GLS for each use.

- 1.  Inspect the pump tube
- 2. Check the discharge tube
- 3. Install the bottle
- 4. Icing the bottle (optional)
- 5. Connect a power source
- 6. Connect a suction line and strainer
- 7. External connections (essential for flow-paced sampling or sampler inhibiting)
- 8.  Place the GLS in position
- 9. Calibrate sample volumes (optional)
- 10. Lock the GLS (optional)

## Inspecting the Pump Tube

Inspect the pump tube before running a program. If the pump tube fails, the GLS will not be able to collect samples.

### **⚠ WARNING**

**Moving parts can cause injuries. Remove power before inspecting pump tube.**

### **⚠ AVERTISSEMENT**

**Les pièces en mouvement de la pompe peuvent causer la blessure. Déconnectez l'électricité avant d'inspecter la tuyauterie à l'intérieur de la pompe.**

To inspect the pump tube:

1. Disconnect the power from the 12V Input Power connector.
2. Remove the pump housing cover by loosening the four thumbscrews.
3. Visually inspect the pump tube for cracks where it is compressed by the rollers. If the tube is cracked, it must be replaced.

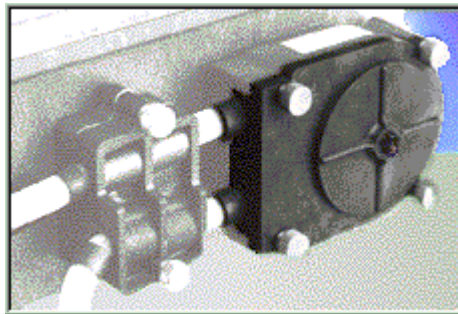

Pump Housing Cover  
and Thumbscrews

4. Visually inspect the inside of the pump housing. The housing and rollers should be free from debris.
5. Replace the pump housing cover and tighten the thumbscrews.

### **Notes:**

- The GLS will display a pump tube warning as part of the View Log screens when it exceeds 500,000 pump counts. This is the recommended pump tube replacement interval. The pump tube warning is based on a number of pump revolutions. The GLS cannot "detect" a weak or worn pump tube. The pump tube replacement interval should be sufficient for most applications. If you are sampling abrasive liquids or liquids with a high content of suspended solids, you may find that the pump tube requires replacement more frequently.
- The GLS automatically resets the pump tube count to 500,000 after it displays the warning message.
- Isco pump tubes are made from medical-grade Silastic™ tubing. This tubing will not contribute any organic material to the samples.

## Discharge Tube

The discharge tube is located inside the center section. It is a 3/8 inch (9 mm) I.D., 8-1/4 inch (210 mm) long piece of medical-grade Silastic™ tubing.

The discharge tube should be well fitted over the bulkhead fitting and routed through the tube guide. The tube must be free of twists or kinks. The tube should extend about 1-1/2 inches (38 mm) past the end of the tube guide (even with the bottom of the center section). This length of tubing is necessary for the GLS to detect an overfilled bottle.



Discharge Tube and Tube Guide

## Installing a Bottle

The base section of the GLS is designed to hold five different types of bottles:



**2.5 gallon (10 liter)**

- Polyethylene
- Glass

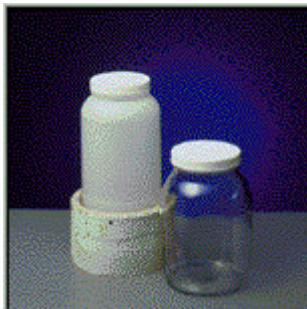

**1 gallon (3.8 liter)**

- Polyethylene
- Glass

(Both require the use  
of the bottle deck)



**2 gallon (7.6 liter)**

- ProPak Liner

(Cap removed)

To install the bottle:

- **2.5 and 2 gallon (10 and 7.6 liter)** – place the bottle in the GLS base section.
- **1 gallon (3.8 liter)** – place the bottle deck into the GLS base section. Set the bottle on top of the bottle deck.

## Sample Cooling

You can cool the samples by placing crushed ice around the outside of the bottle. When using a 2 or 2.5 gallon (7.6 or 10 liter) bottle, the base section can hold 10 pounds (4.5 kg) of ice. When a bottle deck and 1 gallon (3.8 liter) bottle is installed, the base section can hold 14 pounds (6.3 kg) of ice. Frozen gel packs are sometimes a convenient alternative to ice.

The center section and base of the GLS are insulated.

For maximum cooling, fill the base (with the bottle and deck in place) with water and freeze the base section and its contents.

## Installing a Power Source

The GLS must be powered by a 12-Volt DC power source. Isco recommends using one of the following Model 900 series power sources:

### Batteries –

- Model 934 Nickel Cadmium Battery, 4.0Ah
- Model 946 Lead-Acid Battery, 6.5Ah

### Power Packs –

- Model 913 High Capacity Power Pack, 120 Volts AC
- Model 923 High Capacity Power Pack, 240 Volts AC
- Model 914 Battery Backed Power Pack, 120 Volts AC
- Model 924 Battery Backed Power Pack, 240 Volts AC

To install an Isco Model 900 power source:

1. Place the power source into the center section recess. Refer to the photos below for correct positions:

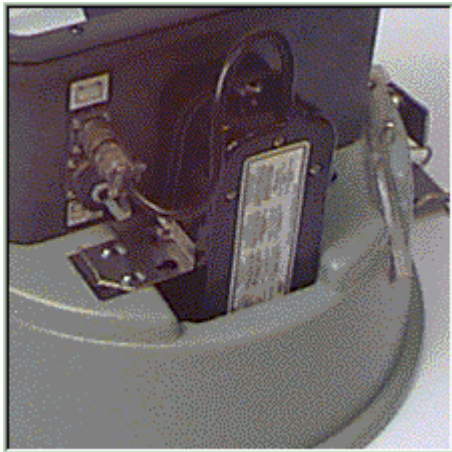

Nickel-cadmium Battery and Power Packs

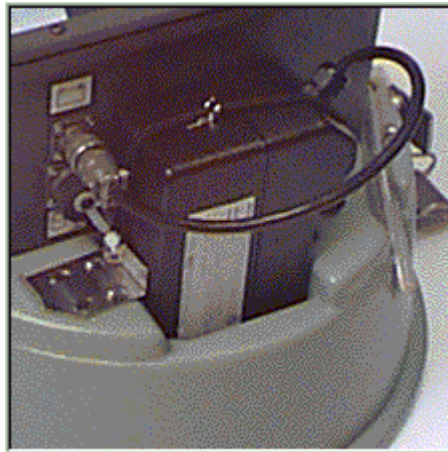

Lead-acid Battery

2. Secure the power source by pulling the elastic bands over it and attach the clip to the two posts. Note that there are two sets of holes – use the set that places the clip against the power source.
3. Attach the two-pin connector to the Input Power connector on the back of the controller.
4. Power Packs Only – Route the AC line cord through the center section's Tubing/Cable port.

### Notes:

- If you use a battery to power the GLS, always install a fully charged one before running a program.
- Refer to Isco's *Power Products Guide*, P/N 60-9003-092 for a complete description of each power source.



## The Suction Line and Strainer

### Overview:

The suction line carries the liquid from the sampling point to the GLS pump tubing. The GLS is designed to use:

- 1/4-inch (6 mm) I.D. Vinyl tubing
- 3/8-inch (9 mm) I.D. Vinyl tubing
- 3/8-inch (9 mm) I.D. Teflon® tubing with a protective polyethylene jacket

The strainer reduces the possibility of debris plugging the suction line. Several types are available to choose from. Some types include a debris deflector that prevents debris from accumulating around the hose clamp.

- Polypropylene body (3/8-inch includes a debris deflector)
- CPVC body (3/8-inch I.D. only, includes a debris deflector)
- Stainless Steel
- Stainless Steel Low Flow

Your application will dictate the best combination of suction line and strainer.

To prepare the suction line and strainer:

1. Cut the suction line to the shortest feasible length.
2. Attach a strainer to the suction line.
3. Connect the suction line to the pump tube.

**Note:** The vinyl suction line does contain a very low ppm (parts per million) level of phenols. If this affects your samples, use the Teflon suction line.

## Cutting the Suction Line

The suction line should be cut to the shortest feasible length. This reduces the possibility of cross-contamination between sample volumes and extends the battery life. The suction line can be easily cut with a knife.

When cutting the suction line, keep in mind that the length must be cut to the nearest whole foot or decimeter. The length is measured from end to end, without the strainer or tubing coupler.

If you have altered the length, press the Calibrate button , and enter the new suction line dimensions.

## Attaching the Strainer

Items required: Strainer                      Hose clamp  
                         Suction line                      Debris Deflector (optional)  
                         Flat-blade screwdriver or a 1/8-inch nut driver

To attach the strainer to the suction line:

1. (Optional) Slide the debris deflector, narrow end first, onto the suction line.
2. Slide the clamp onto the suction line.
3. Push the tapered end of the strainer into the suction line.
4. Position the hose clamp over the tapered end and tighten it.
5. If you installed a debris deflector in step one, slide the detector over the hose clamp. Push the deflector firmly onto the body of the strainer.

## Connecting the Suction Line

### Vinyl Suction Line

To connect the 1/4-inch (6 mm) or 3/8-inch (9 mm) vinyl suction line to the pump tube:

Items required: Suction line with strainer attached  
Tubing coupler

1. Insert the end of the tubing coupler with the black clamp into the upper pump tube.
2. Position the black clamp around the pump tube and squeeze the sides of the clamp together.
3. Push the vinyl suction line onto the end of the tubing coupler with the white clamp.
4. Position the white clamp around the suction line and squeeze the ends together.

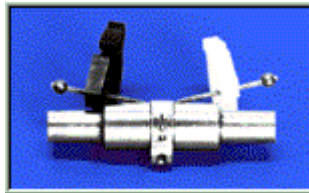

Tubing Coupler  
(3/8-inch shown)



Finished connection

### Teflon Suction Line

To connect the 3/8-inch (9 mm) Teflon suction line to the pump tube:

Items required: Suction line with strainer attached  
3/4-inch (19 mm) diameter hose clamp (plastic or stainless steel recommended)

1. Place a hose clamp on the upper pump tube.
2. Insert about 1 inch (25 mm) of the Teflon suction line into the upper pump tube.
3. Position the clamp over the joined area and tighten it.

## Connecting External Devices

The GLS can be used with external devices that control the sampler pacing, sampler inhibiting, or both. The sampler pacing input can control the rate of sample collection so that it is proportional to the flow rate of a channel. This input must be used when the Flow Paced program option is selected. The sampler inhibit input can delay the GLS operation until a monitored parameter meets user-defined conditions.

These devices connect to the 6-pin Flow Meter Connector located on the back of the GLS controller. Compatible Isco devices include:

Pacing and Inhibiting devices:

- 4100 Series Flow Loggers
- 4200 Series Flow Meters

Pacing devices (non-Isco device interfaces):

- 4-20 mA Input Interface
- Pulse Duration Input Interface

Inhibiting devices:

- PAL 1101 pH and Temperature Actuator/Logger
- Liquid Level Actuator

### Notes:

- Flow pacing input signal (pin C) requirements – a 5 to 15 volt DC pulse or isolated contact closure of at least 25 milliseconds in duration.
- Sampler inhibit signal (pin F) requirements – a low (grounded) level of at least 5 seconds inhibits the operation. A high (or open) level of at least 5 seconds in duration restores the operation.

## Positioning the GLS

There are a few considerations when selecting a site for the GLS. The foremost concern should be personal safety.



**The installation and use of this product may subject you to hazardous working conditions that can cause you serious or fatal injuries. Take any necessary precautions before entering the worksite. Install and operate this product in accordance with all applicable safety and health regulations, and local ordinances.**



**L'installation et l'emploi de ce produit peuvent vous soumettre aux périls qui peuvent vous causer les blessures sérieuses ou fatales. Prenez toutes précautions nécessaires avant d'entrer l'endroit où se trouve l'échantillonneur. Installez et faites fonctionner ce produit selon les règlements de sûreté et de la santé, et toutes ordonnances locales aussi.**

The following points should also be considered:

- Level surface – The GLS should be placed on a level surface to prevent tipping or spills.
- Support – The surface or mounting method must be able to support the GLS at full capacity. A GLS with battery, full sample bottle, and ice may weigh as much as 63 pounds (28.6 kg).
- Environmental – The GLS is designed for use in harsh environments. However, you should avoid installing the GLS in locations where its components are subject to chemical attack. Also, prolonged exposure to direct sunlight will eventually damage the ABS exterior.
- Avoid submersion – Although its controller will resist damage (rated NEMA 4x, 6), the GLS cannot prevent the liquid from entering the base and center sections. Liquid entering the base section while the GLS is submerged will most likely invalidate the collected samples.
- Accessibility – The GLS must be installed in a location where it can be recovered easily without tipping or difficult maneuvering.
- Security – The location may need to provide some degree of security to prevent tampering or vandalism. See also – sampler locking and the program lock option.

The GLS can be installed in a manhole using the optional suspension harness (P/N 60-2954-033) or the Equipment Platform (P/N 60-3004-151). Contact your sales representative or Isco for more information.

After the GLS is in place, the strainer and suction line should be properly positioned.

The strainer should be placed in the stream so that representative samples are collected. The intake should be in the main flow, not in an eddy or at the edge of flow. Its depth in the stream can also be important. An intake placed at the bottom of the stream may result in excess heavy solids, while placement at the top may result in the opposite.

The suction line should always be cut to the shortest possible length. Route the suction line so that it runs continuously downhill. Loops of coiled suction line or low areas where the liquid can pool will hold residual amounts of liquid that will cross-contaminate sample volumes.

The suction line will tend to float when sampling from deep flow streams. Refer to the chart below. If the depths listed in the chart are exceeded, anchor the line securely so that the suction line and strainer do not become dislodged.

Strainer	Vinyl		Teflon
	1/4-inch (6 mm)	3/8-inch (9 mm)	3/8-inch (9 mm)
Stainless Steel	---	22 feet (6.7 m)	15 feet (4.5 m)
Low-Flow Stainless Steel	14 feet (4.2 m)	7 feet (2.1 m)	---
Polypropylene	22 feet (6.7 m)	11 feet (3.3 m)	---
CPVC	---	4 feet (1.2 m)	---

## Locking the GLS

Access to the inside of the GLS can be easily secured by placing a padlock on the carrying handle. Because the carrying handle must be repositioned before gaining access, locking the handle in an upright position secures the top cover, center section and controller, and the base section.



# Programming

## Introduction to GLS Programming

This section shows you how to program the GLS.

In this section you will find:

- The GLS Interface – This explains how you operate the GLS using the keypad and display.
- Operating States – This explains the many states of operation.
- Programming Instructions – This section provides instructions on One-button Programming and Standard Programming.
- Setting the time and date – This section explains how to set the internal clock.

## GLS Interface

### The GLS Interface

The GLS is easily programmed and operated from the controller front panel. The front panel holds the liquid crystal display and the keypad.

The front panel also includes an internal case humidity indicator.

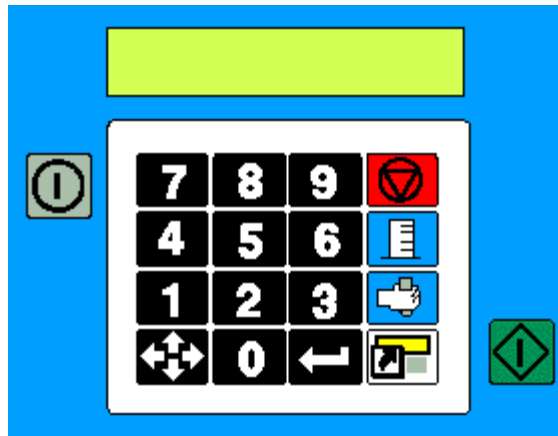

## The GLS Display

The Control panel holds a 2-column, 20-character liquid crystal display. Through this display, the GLS reports all of the possible operating states.

The display will also show messages as needed. These messages alert you to unusual conditions or the need for servicing. Messages may alternate with the current display, such as "ERRORS HAVE OCCURRED," or at the end of a sequence of screens, such as "WARNING: CHANGE PUMP TUBE."

## The GLS Keypad

The GLS accepts input from the 18-button keypad. The operating state will determine which buttons are active.

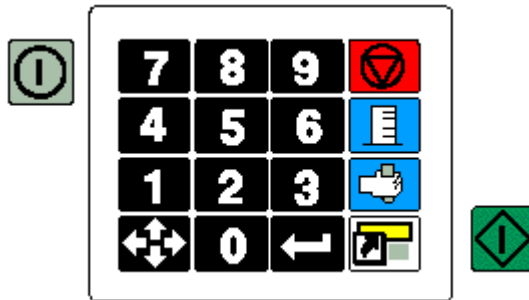



## GLS Operating States

The GLS has many states of operation. States of operation can be classified as either "interactive" or "non-interactive."

### Interactive States

- **Standby** — The display shows "PROGRAM, VIEW LOG," and the current time and date. This is an interactive state and the GLS is waiting for your input. You will see that one of the items is blinking; this is the current selection and will be accepted if the Enter button is pressed. You can change the selected item by pressing the Arrow button.
- **Program** — The display shows programming options or number-entry screens. Again, this is an interactive state through which you can modify the operation of the sampler controller.
- **Paused** — Pressing the Stop key while the sampler is running a program places the GLS in the Paused state. This is an interactive state where you can choose to view the event log, return to the Run state, or halt the sampling routine.
- **Time and Date** — the displays shows "ENTER TIME AND DATE:" This is an interactive state used to set the correct time and date.

### Non-interactive States

- **Off** — The display is blank. In this state, a few sampler functions continue to operate, even without its external 12-volt DC power source. An internal battery powers the real-time clock to maintain the correct date and time. When an external 12-volt DC power source is connected, the GLS will respond only to the On/Off button.
- **Run** — The display shows information about the program that it is running. This is typically the current activity, such as "TAKING SAMPLE \_\_ OF \_\_," or when the next event is to occur, such as "SAMPLE \_\_ OF \_\_ IN MM:SS."
- **Done** — The display shows "PROGRAM DONE." This state reports that the GLS has finished running the program. Pressing any key will place the sampler in the Standby state.
- **View Log** — The display "scrolls" through the event log.

## **Programming**

### Programming the GLS

There are two ways to program the GLS:

- One-button Programming
- Standard Programming

One-button Programming quickly loads program settings from a stored program and runs the sampling routine.

Standard Programming allows you to step through the current GLS program settings, making any necessary modifications.

## One-button Programming

### One-button Programming

The One-button Programming feature of the GLS allows you to load the Stored program settings and run the program in one quick and simple step.

To use the One-button Programming, press —



This sequence of buttons must be pressed within 10 seconds.

### Stored Program

At all times the GLS holds two programs, the Stored program and the Current program. The Stored and Current program settings may or may not be the same. When you press the Go button, the GLS runs the Current program settings.

The One-button Programming restores the Current program settings to that of the Stored program.

The GLS is shipped from the factory with the following stored program settings:

- Time Paced
- 15 Minute Pacing Interval
- 9400 ml Bottle Volume – for 2.5 gallon (10 liter) bottles
- Take 96 Samples – covers a 24-hour time period
- 80 ml Sample Volume
- No Delay to First Sample
- 3/8-inch by 25-foot suction line

**Note:**

Re-initializing the GLS or updating its software will restore the factory program settings.

## Standard Programming

### **Standard Programming**

Standard Programming allows you to step through the current GLS program settings and make any necessary modifications.

To access the Standard Programming, select Program from the Standby screen and press Enter.

The seven-step Standard Programming goes through the following settings:

- Pacing – Choose from time or flow paced sampling. Flow paced sampling requires an external flow metering instrument.
- Interval – Set the pacing interval in minutes or flow pulses.
- Bottle Volume – Enter the capacity of the bottle installed in the GLS base section.
- Number of Samples – Set the number of samples to collect or place the GLS in the Continuous Sampling mode.
- Sample Volume – Enter the desired volume to collect at each sample event.
- Delay to First Sample – Without a delay the GLS will always take the first sample when you press the Go button. This programming step allows you to delay the first sample.
- Suction Line – Enter the type of suction line in use. This step also includes the Sample Volume Calibration procedure.

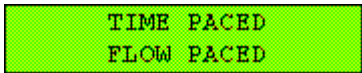

## Sample Pacing

### Programming Step #1 – Pacing



The GLS displays two pacing options – Time Paced and Flow Paced. Select Time to collect samples at uniform time intervals. Select Flow to collect samples based on flow volumes. An input signal from an external instrument is required when you select Flow Paced.

The current selection will be blinking. To program the pacing method:

1. Press the Arrow button  to select an option.
2. Press the Enter button  to accept the blinking option. The GLS loads the option into the current program settings and advances to the next step.

## Pacing Interval

### Programming Step #2 – Pacing Interval

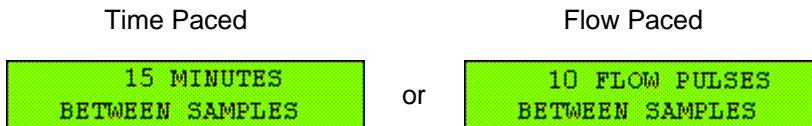

After selecting the pacing method in Step #1, the program now needs a pacing interval. A pacing interval is a value that the sampler will "count down" from after each sample event. Time paced programs will count down an interval in minutes using its internal clock. Flow paced programs will count down the number of flow pulses it receives from an external device.

The Pacing Interval display will show "minutes" or "flow pulses" according to the previously selected pacing method.

You can accept the interval by pressing the Enter button , or change the setting. To change the setting:

1. Enter the new value using the number buttons. The GLS will accept intervals from 1 to 9,999.

**Tip** – If you enter an incorrect value with the number-entry buttons, press the Stop button. The GLS restores the original value and waits for a new value.



2. Press the Enter button  to accept the new value. The GLS loads the value into the current program settings and advances to the next step.

## Bottle Volume

### Programming Step #3 – Bottle Volume

BOTTLE VOLUME:  
9400 mL (3500-9990)

In this programming step, enter the capacity of the bottle installed in the base section of the sampler. As shown on the display, acceptable values range from 3500 to 9990 milliliters.

The GLS typically uses standard bottles provided by Isco. When using Isco's standard bottles refer to the chart below for recommended values. You will note that the value is less than the total capacity. This reduces the possibility of missed samples due to a Bottle Full error, or spills when recovering the sampler.

Bottle Description	Enter this value (in milliliters)...
2.5 gallon (10 liter) glass	9400
2.5 gallon (10 liter) polyethylene	9400
1 gallon (3.8 liter) glass	3500
1 gallon (3.8 liter) polyethylene	3500
2 gallon (7.6 liter) ProPak liner	7000

You may use a non-standard bottle in the GLS. When entering the non-standard bottle volume, it is advisable to enter a value less than the total volume. Again, this will reduce the possibility of missed samples and spills.

To enter the Bottle Volume:

1. Press the appropriate number buttons on the keypad. The GLS requires all four numbers.

**Tip** – If you enter an incorrect value with the number-entry buttons, press the Stop button. The GLS restores the original value and waits for a new value.



2. Press the Enter button  to accept the new value. The GLS loads the value into the current program settings and advances to the next step.

#### Notes:

- The actual total volume deposited in the bottle is subject to a cumulative error.
- The true bottle size can be entered. However, this increases the likelihood that the cumulative error may cause samples to be missed or spilled.
- Overfilling the bottle or missing samples can affect your sampling results. In some applications, missed or spilled samples may render the bottle contents to be less than a representative composite sample.

## Number of Samples

### Programming Step #4 – Number of Samples

TAKE 10 SAMPLES  
(1-470)

Enter the number of samples to collect. To enter the number of samples:

1. Press the appropriate number buttons on the keypad.



**Tip** – If you enter an incorrect value with the number-entry buttons, press the Stop button. The GLS restores the original value and waits for a new value.



2. Press the Enter button  to accept the new value. The GLS loads the value into the current program settings and advances to the next step.

### Continuous Sampling Mode

The GLS can be placed in a Continuous Sampling mode. In this mode, the GLS collects samples without regard for the total number of samples. Samples are collected until the Liquid Detector senses a full bottle condition. (Sample volumes should be greater than 50 ml for the liquid detector to reliably sense this condition.) The GLS then halts the sampling routine. To enable the Continuous Sampling mode:

1. At the "TAKE XX SAMPLES" display, press the Zero button .
2. Press the Enter button . The GLS is placed in the Continuous Sampling mode and advances to the next programming step.

## Sample Volume

### Programming Step #5 – Sample Volume

SAMPLE VOLUME:  
80 mL (10- 930)

Enter the volume to collect at each sampling event. This value must be within the range shown on the GLS display.

To enter the sample volume:

1. Press the appropriate number buttons on the keypad.

**Tip** – If you enter an incorrect value with the number-entry buttons, press the Stop button. The GLS restores the original value and waits for a new value.



2. Press the Enter button  to accept the new value. The GLS loads the value into the current program settings and advances to the next step.

**Note:**

Sample volumes greater than 50 ml are recommended. This volume is necessary for the bottle full detection to work properly.



## Delay to First Sample

### Programming Step #6 – Delay to First Sample

1 MINUTES  
TO FIRST SAMPLE

Enter the delay to the first sample. The acceptable range of values is from 0 to 9,999 minutes.

To enter the delay:

1. Press the appropriate number buttons on the keypad.

**Tip** – If you enter an incorrect value with the number-entry buttons, press the Stop button. The GLS restores the original value and waits for a new value.



2. Press the Enter button  to accept the new value. The GLS loads the value into the current program settings and advances to the next step.

#### Notes

- If you enter "0," the GLS will collect its first sample immediately after you press the Go button.
- If you enter a value greater than zero, the GLS will start a delay time count down when you press the Go button. The GLS collects its first sample when the delay expires.
- After the first sample, all remaining samples are collected at the programmed Pacing Interval.

## Suction Line

### Programming Step #7 – Calibrate Sample Volumes

The display alternates between:

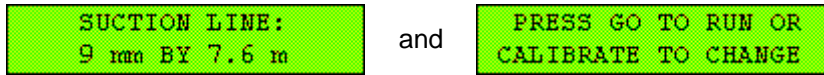

This Suction Line display reports the suction line diameter and length. This information must be correct so that the GLS can deliver sample volumes as programmed. Verify that the diameter and length match the suction line in use.

If the suction line settings are correct, calibration is not necessary. To skip the calibration, press:



The Go button to run the program, or,



The Enter button to accept the values and return to the Standby state.

If the settings do not match the suction line in use, you must enter new values. Press the Calibrate button and proceed with the Calibration steps.





#### Notes:

- While the two displays alternate, the GLS is counting down a five-minute time interval. If you do not press a button during this count down, the GLS times out and automatically runs the current program.
- If your sampling protocol requires the utmost volume accuracy, step through the calibration procedure and check the delivered sample volume. Calibration may improve the GLS's volume accuracy.

## Setting the Time and Date

Should it become necessary to set the time or date, do the following:

1. From the standby state, press the Arrow button  until the time and date is blinking.
2. Press the Enter button  to access time and date entry display. The cursor is waiting for you to enter the current time.
3. Enter the hours with the number entry buttons. The hours must be entered in a 24-hour (military time) format. For example, 5:00 p.m. is 17:00 on a 24-hour clock. Press the Enter button to accept the hour setting and advance the cursor to the minutes.  
**Tip** – If you enter an incorrect value with the number-entry buttons, press the Stop button.  The GLS restores the original setting and waits for a new value.
4. Enter the minutes with the number entry buttons. Press the Enter button to accept the minutes setting and advance the cursor to the day setting.
5. Enter today's date with the number entry buttons. Press the Enter button to accept the date and advance the cursor to the month setting.
6. Enter the number of the month (for example, August = 08) with the number entry buttons. Press the Enter button and the GLS abbreviates the month and advances the cursor to the year setting.
7. Enter the last two digits of the year (for example, 1999 = 99). Press the Enter button to accept the year and return to standby.

**Note:**

The GLS is Year 2000 (Y2K) compliant.

# Calibrating Sample Volumes

## Overview:

The GLS can deliver sample volumes repeatable to  $\pm 10$  ml. The GLS relies on you to enter correct suction line diameter and length values. The GLS uses these values to:

- Generate internal pump tables to "measure" the liquid volume
- Calculate the suction head.

By calculating the suction head, the delivered volumes are not affected by varying liquid levels. The GLS automatically calculates the suction head using input from the Liquid Detector.

Incorrect suction line values or disabling the liquid detector may adversely affect the volume accuracy.

Calibrating the sampler can enhance sample volume accuracy.

To calibrate sample volumes, press the Calibrate button  and follow the steps:

1. Enter the suction line size.
2. Enter the suction line length.
3. If the liquid detector is disabled, the GLS will ask for a manual or "fixed" suction head since it will not be able to calculate the head.
4. Check the sample volume. This process deposits the programmed sample volume into a container so you can measure the delivered volume. You can then enter the actual volume delivered to refine the GLS pump tables. Be sure to disconnect the pump tube at the bulkhead fitting when calibrating samples.

Repeat these steps to check volume accuracy.

## Calibration Step 1



Press the Calibrate button . The GLS advances to the Suction Line Size display.

SUCTION LINE SIZE:  
6 mm 9 mm

The Suction Line Size is the inside diameter (I.D.) of the suction line tubing. Two sizes of suction line may be used with the GLS:

- 1/4-inch (6 mm) I.D.
- 3/8-inch (9 mm) I.D.

To set the suction line size:



3. Determine the size of suction line in use. Compare this to the blinking selection.
4. If the selection is incorrect, press the Arrow button . This will change the blinking selection.
5. Press the Enter button  to accept the selection. The GLS loads the size into the current program settings and advances to the next step.

## Calibration Step 2

SUCTION LINE LENGTH:  
7.6 m {0.9-30.2}

The Suction Line Length is the measured length of tubing in use. The length is measured from end-to-end, without the strainer or tube coupling. When using English units of measure, the suction line tubing must be cut in whole foot lengths. When using metric units of measure, the tubing must be cut in decimeter lengths.

To enter the Suction Line Length:

1. Measure the length of tubing. Cut the tubing if necessary, to the nearest whole foot or decimeter.
2. Enter the tubing length. Press the appropriate number buttons on the keypad.  
**Tip** – If you enter an incorrect value with the number-entry buttons, press the Stop button.  The GLS restores the original value and waits for a new value.
3. Press the Enter button  to accept the value. The GLS loads the length into the current program settings and advances to the next step.

## Calibration Step 3

SUCTION HEAD:  
3.1 m ( 0-7.6 m)

**This step only appears when the liquid detector is disabled.** Since the GLS will be unable to calculate the suction head as it collects each sample, the GLS will ask for a manual or "fixed" suction head. The GLS skips this step when the Liquid Detector is enabled.

To enter the Suction Head:

1. Measure the Suction Head height.
2. Enter the height. Press the appropriate number buttons on the keypad.

**Tip** – If you enter an incorrect value with the number-entry buttons, press the Stop button. The GLS restores the original value and waits for a new value.



3. Press the Enter button  to accept the value. The GLS loads the fixed Suction Head into the current program settings and advances to the next step.

## Calibration Step 4

CHECK SAMPLE VOLUME?  
YES NO

Checking the sample volume is recommended if ultimate accuracy is required by your sampling protocol.

The default selection is NO. To accept this, press the Enter button. The GLS will return to the Standby state.



To check sample volumes, select YES by pressing the Arrow button, and then press the Enter button. The GLS will continue with the calibration steps.



## Calibration Step 5

CALIBRATE VOLUME  
PRESS ↵ WHEN READY!

The GLS will wait while you prepare to collect a sample.

To prepare:

1. Pull the lower pump tube end from the bulkhead fitting.
2. Hold the pump tube outlet over a graduated cylinder, such as Isco's 1000 ml plastic graduated cylinder, P/N 299-0020-00.
3. Press the Enter button  and the GLS will start to collect the sample.

TAKING 200 ml  
CALIBRATE SAMPLE

The GLS displays the screen above and goes through a complete sample collection cycle. The GLS deposits the sample in the graduated cylinder.

## Calibration Step 6



VOLUME DELIVERED  
200 mL

The GLS displays the amount of liquid it has deposited into the graduated cylinder. Measure the volume and compare the numbers. If they match, press Enter and the GLS will return to the Standby state.

If the amounts differ, enter the actual volume delivered. To enter the actual volume:

1. Enter the measured volume. Press the appropriate number buttons on the keypad.

**Tip** – If you enter an incorrect value with the number-entry buttons, press the Stop button. The GLS restores the original value and waits for a new value.



2. Press the Enter button  to accept the value. The GLS updates its internal pump tables. If there is a significant difference between the old and new values, the GLS displays the screen below.

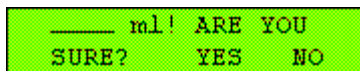

\_\_\_\_\_ mL! ARE YOU  
SURE? YES NO

3. Compare this value with the measured volume.
  - If they match, select YES using the Arrow button and then press Enter.
  - If they do not match, select NO using the Arrow button and then press Enter. The GLS returns to the Volume Delivered screen (step 1, above).

When through with Calibration Step 6, the GLS logs the calibration time in the event log and returns to the Standby state. Be sure to reconnect the pump tube end to the bulkhead fitting.



# Running a Program

## Starting a Program

You can easily start the GLS operation by pressing the Go button . Pressing this button runs the current program.

The GLS operation can also be started with the one-button programming sequence. This action will load the stored program settings as the current settings and run the program.

Generally when you start a program, the GLS will attempt to take its first sample at the start time – unless the first sample is delayed or inhibited.

### Related topics:

- Counting down delay times
- Sampler inhibiting
- Run state displays
- The sample collection cycle
- Pausing or stopping a program
- Post sampling activities

## Counting Down Delay Times

After pressing the Go button , the GLS will immediately take a sample regardless of whether it is a time or flow paced program. However, the Delay to First Sample setting can be used to start the sample collection up to 9,999 minutes after you press Go.

If the Delay to First Sample setting is one or greater, the GLS must count down from the programmed value before drawing its first sample.

During the delay the GLS will display the screen below.

```
FIRST SAMPLE
IN nnnnn:33
```

## Sampler Inhibit

Before the GLS takes its first sample, it checks the inhibit line of the Flow Meter connector. If the GLS detects a logic low (grounded) level, it will suspend the program until the external device returns the line to a logic high (or open) level.

While the GLS is inhibited it will display the screen below.

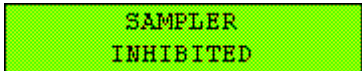

The inhibit line allows an external device, while monitoring parameters of interest, to control the sampler operation. Compatible Isco devices can be configured to inhibit a sampler until a parameter meets user-defined conditions. For example, a 4200 Flow Meter with a Model 201 pH/Temperature Module can be programmed to suspend sample collection until the stream temperature exceeds 100° F.

When the external device releases the inhibit, the GLS will:

- immediately take the first sample
- reset the time or flow pacing interval and begin counting down
- latch the inhibit signal

Latching the inhibit signal means that the GLS will ignore any later inhibit signals from an external device. Once the GLS collects its first sample, its operation will continue until the program is done.

### Notes:

- The GLS will not "store" samples while it is inhibited. The GLS takes no action at all when it counts down a complete time or flow-pacing interval.
- Sampler Inhibit signal (pin F) requirements – a low (grounded) level of at least 5 seconds inhibits the operation. A high (or open) level of at least 5 seconds in duration restores the operation.

## Run State Displays

The GLS updates its display while it is running a program so that you can monitor the status. The Run State displays are listed below.

### Collecting a sample –

As the GLS goes through a sample collection cycle it displays...

<pre>TAKING SAMPLE xxx of yyy</pre>	or	<pre>TAKING SAMPLE xxxx</pre>
Programmed number of samples		Continuous Sampling Mode

...where "xxx" is the current sample number and "yyy" is the programmed number of samples.

### Waiting to sample –

While the GLS counts down the pacing interval it displays...

<pre>SAMPLE xxx of yyy IN mmm:ss</pre>	or	<pre>SAMPLE xxx of yyy IN zzz FLOW PULSES</pre>
Time Paced		Flow Paced

...where "xxx" is the next sample number and "yyy" is the programmed number of samples. If the GLS is in the Continuous Sampling mode, it only displays the next sample number.

### Errors –

If the GLS encounters an error while running a program, the following display alternates with the pacing interval countdown display:

```
ERRORS HAVE OCCURRED
```

### Note:

You can pause a running program to determine the type of error.

## Sample Collection Cycle

Each time the GLS collects a sample (programmed or grab) it runs the pump through a complete sampling cycle. The cycle consists of three actions – Pre-purge, Fill, and Post-purge.

**Pre-purge** – As the GLS waits to collect a sample, some liquid will tend to enter the suction line and debris may collect around the strainer. The pre-purge runs the GLS pump in reverse to force air down through the suction line and strainer. This action will flush the water from the suction line and clear any debris near the strainer. The duration of the pre-purge is automatically calculated by the GLS based on the programmed suction line settings.

**Fill** – After a pre-purge, the GLS pump changes its direction to draw liquid into the suction line. The liquid travels up through the suction line and the pump tube where it then passes through the liquid detector and peristaltic pump. The liquid is transferred to the discharge tube via the bulkhead fitting. The discharge tube deposits the liquid into the bottle. The duration of the fill is controlled by the GLS using input from the programmed volume and suction line settings, and the liquid detector. The Event Mark pin of the Flow Meter connector goes to a high level (+12 Volts DC) at the beginning of the fill and remains high until the fill is complete.

**Post-purge** – After the fill, the GLS again reverses the pump direction to force air down through the suction line. This action clears the entire liquid path to prevent cross-contamination. During the post-purge, the GLS will determine if the bottle is full. Since a short length of discharge tube extends inside the bottle, an over-filled bottle will allow liquid to be drawn back into the discharge tube. If the liquid detector finds that this excess amount of liquid is being returned through the liquid path, the GLS stops the program and indicates that the bottle is full. The duration of the post-purge is automatically calculated by the GLS based on the programmed suction line settings.



## Pausing or Stopping a Program

Press the Stop button  to pause a running program. The GLS will display the paused options screen.

```
RESUME IN m:ss  
VIEW LOG HALT
```

The screen displays three options – Resume, View Log, and Halt.

- Resume – select this option to return to the running program. When the GLS enters the paused state, it starts a five-minute idle time-out. If you do not press a button within five minutes, the GLS will automatically resume the running program.
- View Log – select this option to scroll through the log.
- Halt – select this option to stop the program. Once you stop a program, it cannot be resumed. To run a program the GLS must be restarted.

Use the Arrow button  to select an option. When the desired option is blinking, press the Enter button .

### Note:

The GLS continues to count down the pacing interval while it is paused. Keep in mind that if the count reaches zero the GLS will not take a sample. It records this as a "MISSED SAMPLE – PROGRAM PAUSED" in the log.

## Program Completion

A running program will end in one of three ways:

- Program Completed – The GLS has taken all of the programmed samples.
- Program Halted – Stopped by the user.
- Bottle Full – The GLS detected a full bottle and stopped the program.

## Post-sampling Activities

Typical post-sampling activities include:

- Recovering the sampler
- Viewing the log
- Preparing the sample bottle to return to the lab
- Preparing the GLS for reuse

## **Recovering the Sampler**

When the GLS completes the program, it often must be retrieved and placed in a location that allows you easily gain access to its contents. If you must move the sampler keep the following in mind:

- A GLS with battery, full sample bottle, and ice may weigh as much as 63 pounds (28.6 kg).
- The GLS must be kept level to avoid spilling the bottle's contents.

## **Preparing the Full Sample Bottle**

To prepare a full bottle to return to the lab you must first gain access to the sampler's base. To open the sampler:

1. Place the sampler on a level surface.
2. Rotate the carrying handle from its secured (vertical) position to its open (horizontal) position. Unlock the handle if necessary.
3. Release the two latches that fasten the center section to the base section.
4. Lift the center section from the base and set the center section aside.

Now that you have gained access to the bottle, place a cap on it. Then, lift the bottle out of the base. At this point, it is a good idea to label the bottle with the time, date, and site, along with other pertinent information.

## Log

The log is a recorded history of the last or currently running program. The GLS records key program events, such as start and stop times, and exceptional events, such as power failures or missed samples.

The log can be viewed by selecting the "VIEW LOG" option at the Standby or Paused state displays.

As you begin to view the Log, the GLS reports the following:

- The number of samples it has collected
- Missed samples. The GLS skips this display if there are none to report. If there are, the GLS will report the number of samples missed and the cause. Possible causes are:
  - No liquid detected
  - No more liquid
  - Power fail
  - User stopped pump
  - Paused
  - Pump jammed
  - Program halted
  - Bottle full
- Program start time
- Current status. One of the following will be reported:
  - Program completed
  - Program halted
  - Bottle full
  - Program paused (with number of samples remaining)
- Power lost. If power was lost while the GLS was running the program, it reports the times it was lost and restored. This will be reported whether a sample was missed or not.
- Last sample volume calibration date
- Last programmed date
- Clock set at (time and date)
- Sampler ID and software revision number
- Pump tube warning if the pump counts exceed 500,000. When the GLS displays this message, replace the pump tube to prevent failures. The GLS automatically resets the pump count to zero after displaying this message.

### Note:



Pressing the Go button  clears the log. The only information that the GLS retains from program to program is the Last Calibration Date, Last Programmed Date, Clock Set, and the Sampler ID and Software Revision. The GLS also keeps the current pump count value which is used to determine when to display the pump tube warning. Re-initializing the GLS or updating the software will also clear the log.

## Errors

The GLS can detect program errors or conditions that have caused it to miss a sample. If the GLS encounters an error condition and is still running a program, it alternates the message below with the current display.

ERRORS HAVE OCCURRED

The GLS also makes an entry in the Log, which can be viewed later to determine the cause. Possible log entries are:

- **No liquid detected** – The GLS did not detect any liquid.
- **No more liquid** – The GLS did detect liquid during the fill cycle, but it stopped detecting liquid before a complete sample volume was collected.
- **Power fail** – Power was lost and caused the GLS to miss a sample.
- **User stopped pump** – The user pressed the Stop button while the GLS was collecting a sample.
- **Paused** – The GLS was in the paused state when a sample was to have been initiated.
- **Pump jammed** – The GLS pump jammed during a sample collection cycle.
- **Program halted** – Remaining samples were not collected because the program was halted.
- **Bottle full** – Remaining samples were not collected because the GLS detected a full bottle.



# Grab Samples

Grab samples let you take a single sample on demand, collecting the sample in an external container. You can collect a grab sample while the GLS is running a program, paused, or in standby.

To collect a grab sample:

1. Press the Grab Sample button .

2. The GLS asks how much liquid to collect. Using the number-entry buttons, enter the desired volume (in ml). Press the Enter button to continue.

```
SAMPLE VOLUME :
200 mL (10-9990)
```

3. The GLS waits for you to prepare to collect a grab sample. Pull the lower pump tube from the bulkhead fitting. Hold the end of the tube over a container. Press the Enter button when you are ready.

```
GRAB SAMPLE
PRESS ← WHEN READY!
```

4. The GLS goes through a complete sample collection cycle and deposits the requested amount of liquid in the container.

```
TAKING 200 mL
GRAB SAMPLE
```

5. Return the pump tube to the bulkhead fitting.

## Notes:

- If a grab sample is taken while a program is running, it is not counted as part of the number of samples.
- If you interrupt a running program to collect a grab sample and miss a programmed sample event, it is logged as "PROGRAM PAUSED" error.

# Servicing the Sampler

This section contains instructions necessary to perform routine and preventive maintenance on the GLS and its related components. The topics are outlined below.

## **Routine maintenance** — at user determined intervals

- Cleaning
-  Pump tube replacement
- Discharge tube replacement
- Battery and power pack servicing

## **Preventive maintenance** — as needed

- Replacing the internal desiccant
-  Renewing the desiccant

## **Problem resolution**

- Troubleshooting and self-diagnostics
- Contacting Isco for assistance
- Return instructions
- Replacement parts
- Schematic and Board Layout

## Routine maintenance

### Cleaning

This section contains topics that provide instructions for cleaning the GLS and its components. Select a topic.

- Cleaning the GLS case and controller
- Cleaning the bottles
- Cleaning the suction line, strainer, and tubing.
- Cleaning protocols for priority pollutants and critical sampling. This topic may be used as a guide to develop cleaning methods for equipment engaged in regulatory compliance monitoring.

### Cleaning the GLS

The GLS controller, top cover, center section, base, and bottle deck can be cleaned with warm soapy water or by spraying them with a hose. Avoid using a high-pressure hose to clean the controller. Extreme pressures may damage the label or force water past the control panel seal.

The connectors should be protected when you are cleaning the controller. Cap the Flow Meter connector with the attached cap. Keep a power source connected to protect the 12V Input Power connector, or use the protective cap that was in place when the unit was shipped.

### Cleaning the Bottles

The bottles have a wide mouth to facilitate cleaning. Wash them with a brush and soapy water, or use a dishwasher. Glass bottles may be autoclaved.

The 2 gallon (7.6 liter) ProPak™ system was developed by Isco to offer the greatest convenience in preparing sample containers for re-use. Simply remove the used liner and place a new one in the holder. Used ProPak liners can be disposed of or recycled. When necessary, the holder can be washed with warm soapy water or placed in a dishwasher.

See also: Cleaning protocols for priority pollutants.

### Cleaning the Suction Line and Tubing

The suction line, pump tube, and discharge tube can be cleaned by placing the end of the suction line in a cleaning solution. Press the Grab Sample button to pump the solution through the delivery system. When the delivery system is clean, repeat the pumping with clean water to rinse the lines. If any of these items are severely contaminated, they should be replaced.

The strainer can be cleaned with a brush and soapy water.

See also: Cleaning protocols for priority pollutants.

## Cleaning Protocols for Priority Pollutants

Clean sampling equipment is essential for valid laboratory analysis. Isco recommends that you develop cleaning protocols in consultation with a laboratory analyst when designing the monitoring program. For example, to clean sample bottles, suction line, and pump tubes, Lair (1974) suggests these protocols used by USEPA Region IV Surveillance and Analysis field personnel engaged in NPDES compliance monitoring. The protocols are based on U.S. Environmental Protection Agency Publications EPA-600/4-77-039 (Sampling of Water and Wastewater by Dr. Phillip E. Shelley).

### **Isco Glass Sample Bottles**

1. One spectro-grade acetone rinse.
2. Dishwasher cycle (wash and tap water rinse, no detergent).
3. Acid wash with at least 20 percent hydrochloric acid.
4. Dishwasher cycle (wash and tap water rinse, no detergent).
5. Replace in covered Isco tubs.

### **Vinyl Suction Line**

Use new suction line for each new sampling setup, therefore, no cleaning is required. When sampling for organic compounds, use Teflon suction line.

### **Teflon Suction Line**

1. Rinse twice with spectro-grade acetone.
2. Rinse thoroughly with hot tap water using a brush, if possible, to remove particulate matter and surface film.
3. Rinse thoroughly three times with tap water.
4. Acid wash with at least 20 percent hydrochloric acid.
5. Rinse thoroughly three times with tap water.
6. Rinse thoroughly three times with distilled water.
7. Rinse thoroughly with petroleum ether and dry by pulling air through the line.
8. Dry overnight in a warm oven (use an oven temperature of lower than 150 degrees F), if possible.
9. Cap ends with aluminum foil.

### **Isco Pump and Discharge Tubes**

1. Rinse by pumping hot tap water through the tube for at least 2 minutes.
2. Acid wash the tube by pumping at least a 20 percent solution of hydrochloric acid through the tube for at least 2 minutes.
3. Rinse by pumping hot tap water through the tube for at least 2 minutes.
4. Rinse by pumping distilled water through the tube for at least 2 minutes.

### **Note:**

For critical sampling applications, consider replacing the suction line, pump tube, and discharge tube. Replacement eliminates the possibility of any cross contamination from previous sampling sites.

## Replacing the Pump Tube

The pump tube is subject to wear during pump operation. It should be replaced when the GLS displays the pump tube warning at 500,000 pump counts, or when inspection of the tube reveals any cracks along its side.

### **⚠ WARNING**

**Moving parts can cause injuries. Remove power before replacing the pump tube.**

### **⚠ AVERTISSEMENT**

**Les pièces en mouvement de la pompe peuvent causer la blessure. Déconnectez l'électricité avant d'inspecter la tuyauterie à l'intérieur de la pompe.**

To remove the pump tube:

1. Disconnect the power from the 12V Input Power connector.
2. Disconnect the suction line and pull the pump tube from the bulkhead fitting.
3. Loosen the two thumbscrews and remove the liquid detector cover.
4. Loosen the four thumbscrews and remove the pump housing cover.
5. Pull the pump tube out of the pump housing. Rotating the pump rollers will help free the tube.

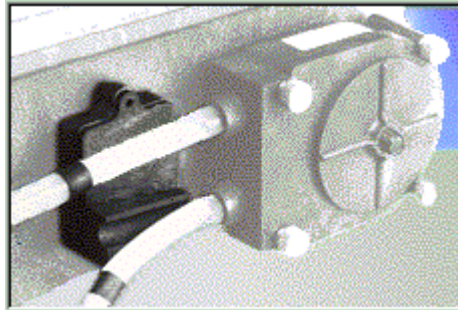

Liquid detector cover removed

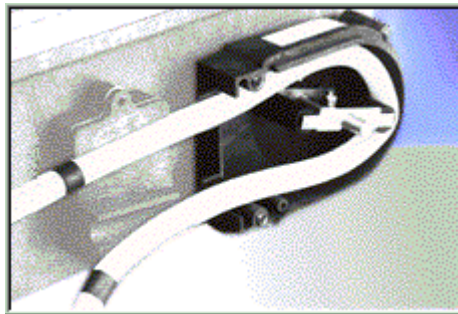

Pump housing cover removed

Clean the inside of the pump housing if necessary.

### **Note:**

Isco replacement pump tubes are marked with two black bands. These bands are used to correctly locate the tubing in the liquid detector and the pump. Position the pump inlet, or short end, in the upper groove of the liquid detector. The band should be placed at the outer edge of the liquid detector.

To replace the pump tube:

1. Slip the pump tube under the pump rollers. Rotating the rollers as you do this will help to slide the tube into the pump.
2. Position the pump tube by aligning the bands at the outer edge of the liquid detector.
3. Replace the liquid detector and pump housing covers. The thumbscrews should be fully hand-tightened.
4. Connect the pump outlet end to the bulkhead fitting. Connect the suction line to the pump inlet.
5. Reconnect the power.

**Notes:**

- Replacement pump tubes, P/N 60-2954-030, are available from Isco.
- If you are cutting replacement tubes from bulk Silastic tubing, cut the length to 27.75 inches (705 mm). Since the bulk tubing will not have bands to mark the correct position, ensure that 18.25 inches (490 mm) of tubing is inside the liquid detector and pump, and that the tube is not kinked where it fits over the bulkhead fitting.
- The factory set value of 500,000 pump counts will deliver approximately 500 samples of 200 ml each, using a 3/8-inch by 10-foot suction line at a 5-foot suction head.
- The peristaltic pump and tube will perform the best when you:
  - Use Isco replacement pump tubes or bulk tubing.
  - Install the tube properly, aligning the inside edges of the bands with the outside edges of the liquid detector.
  - Follow the natural curve of the pump tube when fitting the tube inside the pump housing.
  - Use the shortest possible length of suction line.

## Replacing the Discharge Tube

The discharge tube does not "wear out" under normal circumstances. However, some sampling protocols may require new tubing, or that the tubing be cleaned, before running each program.

To replace the discharge tube:

1. Remove the two thumbscrews that secure the discharge tube guide.
2. Lift the discharge tube guide and pull the tube off of the bulkhead fitting.
3. Slide the old tube out of the guide.
4. Insert the replacement tube. Replacement tubes should be a 3/8 inch (9 mm) I.D., 8-1/4 inch (210 mm) long piece of Silastic™ tubing, available from Isco (P/N 60-2953-032).
5. Push the end of the new discharge tube onto the bulkhead fitting.
6. Properly position the tube guide and tighten the two thumbscrews.
7. Adjust the tube so that 1-1/2 inches (38 mm) of tubing extends beyond the end of the tube guide. This length of tubing is necessary for the GLS to detect an overfilled bottle.



Discharge Tube and Tube Guide

## Servicing Batteries and Power Packs

If you are using a battery to power the GLS, Isco recommends that you install a freshly charged battery before starting each program. Refer to the Power Products Guide for instructions on servicing Isco power packs and batteries.

## Preventive maintenance

### Replacing the Internal Desiccant

The GLS uses a bag of desiccant to protect its internal components from moisture damage. When the internal case humidity exceeds 30%, the desiccant should be replaced. The internal case humidity is shown on the indicator visible through the front panel label. The indicator turns pink or white when the humidity level exceeds the printed value. Ideally, all three sections of the indicator should be blue.

If the 20 and 30% sections are pink or white, replace the desiccant.

1. Disconnect the power from the 12V Input Power connector.
2. Remove the 10 screws that attach the GLS front panel and bezel.
3. Remove the bezel.



The GLS controller contains electronic circuitry that can be damaged by static discharge. Open the controller only in a static-free environment.



Le contrôleur de l'échantillonneur «GLS» contient les circuits électroniques qui peuvent être endommagés par la décharge électrostatique. Démontez le contrôleur dans un environnement statique-libre seulement.

4. Lift the front panel slowly so that the connecting wires are not pulled excessively.

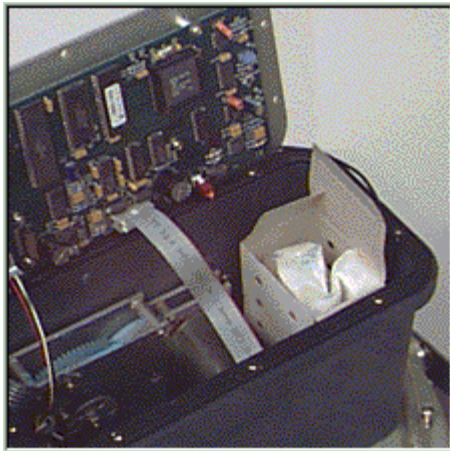

Internal Desiccant

5. While holding the front panel up, open the cardboard box and remove the bag of desiccant. Do not try to remove the cardboard box – it is firmly attached to the side of the case. Attempting to remove the box may damage the box.
6. Insert a new or renewed bag of desiccant.
7. Visually inspect the internal components. Corrosion, residue, or other evidence of moisture damage will indicate a need for cleaning or repair. Contact Isco for assistance.



8. Inspect the front panel gasket. It should fit properly in the case and its surface should be clean and smooth.
9. Replace the front panel using care to ensure that the wiring will be free of the gear train.
10. Replace the bezel and screws. Tighten the 10 screws in an even, cross-torquing pattern.

The internal humidity indicator should return to its normal blue color in a few hours.

## Renewing the Desiccant



Desiccant may produce irritating fumes when heated. To reduce the hazard of the fumes:

- Use a vented oven in a well-ventilated room.
- Do not remain in the room while recharging is taking place.
- Use the recommended temperature.

There have been reports of irritating fumes coming from the desiccant during reactivation. While our attempts to duplicate the problem have been unsuccessful, we still urge you to use caution.



Le dessicatif peuvent produire des vapeurs irritatives quand on le chauffe. Pour réduire le hasard des vapeurs:

- Utiliser un four dans une hotte chimique à ventilateur et dans une pièce bien-aérée.
- Ne pas rester dans la pièce pendant que le dessicatif est chauffé.
- Chauffer le dessicatif à la température recommandée seulement. Ne pas le surchauffer.

Nous avons reçu des rapports des vapeurs irritantes qui sont émises du dessicatif pendant la régénération. Nous avons essayé de dupliquer cette émission des vapeurs sans résultat. Néanmoins, nous vous exhortons à la prudence. Les «MSDS» (les rapports des hasards des agents chimiques utilisés par l'échantillonneur) sont trouvés dans le dossier «Acrobat»

### **To renew the desiccant:**

1. Remove the bag from the GLS controller.
2. Place a sheet of brown paper on a flat metal sheet. You can use a brown grocery bag and a typical cookie sheet.
3. Place the bag on the sheet. If you are recharging several bags, do not stack the bags on top of each other or allow them to touch.
4. Place in a vented, circulating forced air, convection oven in a well-ventilated room. Allow two inches of air space between the top of the bag and the next rack. Keep the tray a minimum of 16 inches from the heating element.
5. Heat the bag at a temperature of 240 to 250° F (116 to 121° C) for 12 to 16 hours.
6. At the end of the time period, the bag should be immediately removed and placed in an airtight container for cooling.
7. When the bag has cooled to room temperature, it may be returned to the GLS controller.

The desiccant will be recharged to approximately 80 to 90% of its previous capacity. After repeated renewing, the desiccant bag may require replacement.

Some bags will have the temperature and time for renewing the desiccant printed on the bag. If they differ, use the temperature and time printed on the bag.

## Diagnostics and Repair

### GLS Self-diagnostics

If you are experiencing problems with the GLS, contact Isco's Repair Service Department. Simple difficulties can often be diagnosed over the telephone. Before contacting Isco however, take a few moments to ensure that several common problems are first eliminated.

- Ensure that the power supply is adequate. Low power can cause a variety of problems. Simply replacing the battery with a freshly charged unit, or replacing the power pack can correct many faults.
- Ensure that the liquid delivery system is in good condition. The tubing should be free from leaks caused by pinholes or cracks. Ensure that the tubing is not plugged by debris.
- Clear debris away from the end of the strainer and ensure that it is submerged deep enough to supply liquid for the entire fill portion of the sampling cycle.

If the cause of the problem cannot be determined, the GLS self-diagnostics routine can be used to test the sampler's functions.

To run the basic level diagnostics:

1. Press **3** **4** **2** **4** **←** at the Standby display. The GLS enters the diagnostics mode.
2. The GLS tests the RAM (Random Access Memory). The GLS displays the RAM test results for four seconds then advances to the next test. If the GLS reports "RAM TEST FAILED" contact Isco. RAM stores program settings, log data, internal counters, pump tables, etc.
3. The GLS tests the ROM (Read Only Memory). The GLS displays the ROM test results for four seconds and then advances to the next test. If the GLS reports "ROM TEST FAILED" contact Isco. ROM stores the embedded software.
4. The GLS tests the liquid crystal display (LCD). The cursor moves across the LCD turning on every pixel, then turning off every pixel. Next, the GLS displays characters on the display. Contact Isco if the pixels or characters do not appear correctly.
5. The GLS queries "TEST PUMP?". Use the Arrow button to choose an option and press the Enter button to select it. Select "NO" to skip the pump test and advance to the next test. Select "YES" and the GLS runs the pump in both directions – pumping and purging. At the end of each direction, it displays an On/Off ratio. This ratio should be between 0.50 and 2.00. Contact Isco if the ratio is outside of this range. A count near 1.00 is typical.
6. The GLS queries "TEST LIQUID DETECT?". Use the Arrow button to choose an option and press the Enter button to select it. Select "NO" to skip the liquid detect test and advance to the next function (step 9). Select "YES" and the GLS enters the liquid detector test.
7. (Liquid Detector Test, continued) The GLS displays "LIQUID DETECT TEST: PRESS ↵ WHEN READY." Ensure that the end of the suction line is in water and there is something to catch the liquid if it is discharged from the pump. Press the Enter button when you are ready.
8. (Liquid Detector Test, continued) The GLS pumps liquid and attempts to detect the liquid in the pump tube. It reports "LIQUID DETECT RINSE (#)" as each of the five rinse cycles are accomplished. When the GLS does not detect liquid it reports the reason and waits for a response. At this point you should:

- Verify that liquid was present in the pump tube during the pumping.
- Verify that the pump tube is installed correctly. The inside edges of the black bands should be even with the outside edges of the liquid detector.
- Ensure that the liquid detector cover is firmly seated over the pump tube and the thumbscrews are tight.

After checking the items above, rerun the liquid detect test by pressing any button (except the Stop and On/Off) to return to step 6. If the above steps did not remedy the problem, contact Isco. If you press the Stop button, the GLS skips the liquid detector test and advances to step 9.

9. The GLS queries "RE-INITIALIZE?". Re-initializing the GLS resets the stored and current program settings to the factory defaults and clears the log. To skip the reset, select "NO" and the GLS returns to the Standby state. To reset the program settings, select YES. The GLS will ask if you are sure. Select YES and the GLS will load the default settings and turn itself off.

## Contacting Isco for Assistance

Contacting Isco:

Isco, Inc.  
P.O. Box 82531  
Lincoln, Nebraska 68501 USA

Phone: (402) 464-0231  
USA & Canada: (800) 228-4373  
Fax: (402) 465-3022

e-mail: Product Information: [info@isco.com](mailto:info@isco.com)  
Technical Service: [service@isco.com](mailto:service@isco.com)

World Wide Web: <http://www.isco.com>

## Return Instructions

Should it become necessary to return the GLS to the factory for repair, please contact Isco first and obtain a Return Authorization Number (RAN). This will aid in the prompt repair and return of the sampler.

When returning the GLS, the unit should be cleaned and packed in the original shipping containers. If the original container is not available, prepare the sampler as described below.

1. Assemble all of the components, latching the sections together.
2. Place the sampler in a bag.
3. Select a cardboard box at least 6 inches (150 mm) longer in each dimension.
4. Place the sampler in the box.
5. Fill the box equally with resilient packing material (shredded paper, bubble pack, expanded foam pieces, etc.).
6. Include a note describing the malfunction or reason for return, and reference the RAN.
7. Seal the box and ship to the address listed below.

Consulting with Isco's Repair Service Department will often determine that only the GLS controller requires servicing. The controller can be removed and shipped without the top cover, center section, and base to save freight charges. To remove the controller and ship it:

1. Disconnect the suction line from the pump tube.
2. Disconnect the pump tube from the bulkhead fitting.
3. Disconnect any items connected to the 12V Input Power and Flow Meter connectors. Place the cap on the Flow meter connector port.
4. Release the two latches holding the center section and base together.
5. Turn the center section over and remove the four screws that mount the controller.
6. Place the controller in a bag.
7. Place the controller in a box at least 6 inches (150 mm) longer in each dimension and fill the box equally with resilient packing material.
8. Include a note describing the malfunction or reason for return, and reference the RAN.
9. Seal the box and ship to the address listed below.

Ship to:

Isco, Inc.  
4700 Superior Street  
Lincoln, Nebraska, USA 68504

**Note:** Your warranty describes conditions under which Isco will pay surface shipping costs.

## Replacement Parts

Replacement parts are available from Isco. Contact Isco's Customer Service Department for ordering information. A listing of replacement parts is located near the end of this manual.

GLS Replacement Parts

## Schematic and Board Layout

The GLS electrical schematic and circuit board layout are located near the end of this manual.

[GLS Schematics](#)

## GLS Options

Several software-based options are available for the GLS.

- Program Storage – store a program for easy recall.
- Liquid Detector Disable – turn off the liquid detector for difficult sampling applications.
- Program Lock – adds password protection to sampler programming and operation.
- Foreign Languages – The GLS can be shipped with foreign language displays.

### Storing a Program

GLS is shipped with default program settings as its stored program. You can overwrite the stored program settings with your own program by using the Program Store function.

To store a program:

1. Modify the current program using the standard programming.
2. Press **7 8 6 7 3**  while in the Standby state. The GLS displays "PROGRAM STORED" for four seconds.

The current program settings are now saved in the GLS memory as the Stored Program. In the field, recall and run the program with the One-button programming procedure.

#### **Note:**



The stored program settings are held in the sampler's memory until the software is updated or the GLS is re-initialized. Either of these actions will restore the factory default program settings.

### Liquid Detector Disable

It is possible to disable the operation of the liquid detector. Typically, there are only two applications where this may be beneficial – collecting samples that include a large amount of foam, or collecting samples from pressurized lines.

Keep in mind that disabling the liquid detector will affect the sample collection in several ways. The most significant effect is the sample volume accuracy. Although you can calibrate the sample volumes at a fixed suction head, the GLS will be unable to compensate for varying stream levels. Secondly, the GLS will not be able to detect a full bottle. A disabled liquid detector may increase the risk of overfilling the bottle. Lastly, the GLS will not be able to detect and log missed samples caused by NO LIQUID or NO MORE LIQUID.

To disable the liquid detector:

1. Press **5 3 9 0**  while in the Standby state.
2. The GLS displays "USE LIQUID DETECTOR?". Select NO to disable the liquid detector. Selecting YES restores the operation. 
3. Press the Enter button to accept the blinking option and the GLS returns to the Standby state.



## Program Lock

The Program Lock adds password protection to the sampler operation. When the Program Lock is enabled, you must enter a password before entering the programming mode and before pausing or halting a running program.

The Program Lock is a **factory-installed option**. This option should be specified at the time of ordering, or you can return the controller to Isco to have the option installed.

When the Program Lock function is installed, the LOCK option appears on the Standby display.

```
PROGRAM VIEW LOG
hh:mm ddmmyy LOCK
```

The LOCK option on the Standby display allows you to enable or disable the password protection and to change the password. A review of the LOCK option displays appears below.

1. Press the Arrow button  until "LOCK" is blinking.

2. Press the Enter button  to accept the selection.

3. If the Lock is currently enabled you will be asked to enter the password before modifying any settings. The GLS is shipped from the factory with a default password of "457." Press the number buttons to enter the password and the display returns an asterisk for each button pressed. Press the Enter button to continue.

```
ENTER PASSWORD:
XXXXX
```

4. The next display allows you to enable or disable the password protection. Selecting YES turns the password protection on and advances to step 5. Selecting NO turns the protection off and the GLS returns to the Standby state.

```
USE PROGRAM LOCK?
YES NO
```

5. The GLS queries "CHANGE PASSWORD?". If you select YES the GLS advances to the password entry displays in steps 6 and 7. If you select NO, the GLS retains the existing password and returns to the Standby state.

```
CHANGE PASSWORD?
YES NO
```

6. Use the number-entry buttons to enter the new password. A valid password uses any combination of numbers 0 through 9. The password can use as many as five digits. As you enter the numbers, the GLS displays asterisks to

```
ENTER NEW PASSWORD:
```

"hide" the password. Press the Enter button to accept the password and advance to step 7.

7. The GLS asks you to confirm the password by re-entering it. Again, use the number-entry buttons to enter the password and then press the Enter button to accept it. When you successfully confirm the password, the GLS returns to the Standby state. If the confirmation is unsuccessful, the GLS notifies you that the passwords are different and returns you to step 6.



REENTER PASSWORD:

**Notes:**

- While a program is running, it is possible to halt the operation of the pump without the password. Pressing the Stop button will halt the current sample and prompt you to ENTER PASSWORD. Entering the correct password places the GLS in the Paused state. If the password is incorrect, or if there is no password entered within 60 seconds, the sampler resumes the count down to the next sample. In any case, the GLS logs the missed sample as USER STOPPED PUMP.
- Any samples that would have been taken while the sampler is waiting for password entry will be logged as missed due to PROGRAM PAUSED.

## Foreign Language Displays

The GLS is shipped with English language displays unless a different language is specified at the time of ordering. Other available languages are listed below:

- French
- German
- Italian
- Spanish

Foreign language displays are a **factory-installed option**. This language should be specified at the time of ordering.

## Software Updates

Isco believes in continually improving its product and at times will release updated versions of software.

The GLS uses Flash memory to store its software. With Flash technology you can upgrade your sampler's software without sending it back to the factory or replacing a chip.

The software is updated by transferring a binary file (.BIN) from a PC to the GLS. This requires the new binary file, a PC-to-GLS connect cable (Isco P/N 60-2954-021), and a program running on your PC. Isco has three software programs that may be used to update the instrument software – Flowlink™ 3, Update Software (shipped with Flowlink 4 for Windows), and Flash Update.

**Note:**

When connecting to the GLS, a baud rate of 19,200 is recommended.

## Accessories

### Order Information

Prices are available upon request. To order any item, contact your sales representative or Isco. You may note that the part name listed on your order acknowledgment and invoice and may be different than the name listed here. When examining these documents, use the part number for reference.

### Bottles

68-6700-020	1 gallon polyethylene round bottles with caps, quantity of 4
68-2910-004	1 gallon glass round bottle with cap and liner, qty 1
68-6700-021	1 gallon glass round bottles with caps and liners, qty 4
299-0013-004	2.5 gallon polyethylene round bottle with cap, qty 1
68-2700-005	2.5 gallon glass round bottle with cap and liner, qty 1

### General Accessories

60-2954-030	Pump tube, GLS, 27.75 inches long
68-1680-061	Silastic pump tubing, bulk 15' length, for pump and discharge tubes
68-1680-065	Silastic pump tubing, bulk 50' length, for pump and discharge tubes
299-0020-000	Plastic graduated cylinder, 1000 ml, for sample volume calibration
60-2954-033	Suspension Harness Assembly, GLS

### Suction line and strainers

60-3704-067	1/4" ID x 10' vinyl suction line with weighted polypropylene bodied strainer
60-3704-068	1/4" ID x 25' vinyl suction line with weighted polypropylene bodied strainer
60-3704-071	3/8" ID x 10' vinyl suction line with weighted polypropylene bodied strainer
60-3704-072	3/8" ID x 25' vinyl suction line with weighted polypropylene bodied strainer
60-1683-146	3/8" ID x 10' Teflon suction line with protective coating, without strainer
60-2703-114	3/8" ID x 25' Teflon suction line with protective coating, without strainer
60-1394-070	Weighted strainer only, 1/4", polypropylene body
60-2903-081	Low flow strainer only, 1/4", all stainless steel
60-1684-110	Weighted strainer only, 3/8", all stainless steel
60-1394-071	Weighted strainer only, 3/8", polypropylene body
60-2903-079	Low flow strainer only, 3/8", all stainless steel (not recommended for use with Teflon suction line)
60-3704-066	Weighted strainer only, 3/8", CPVC body
68-1680-055	1/4" ID vinyl tubing, bulk 100'
68-1680-056	1/4" ID vinyl tubing, bulk 500'
68-1680-057	1/4" ID vinyl tubing, bulk 1000'
68-1680-058	3/8" ID vinyl tubing, bulk 100'
68-1680-059	3/8" ID vinyl tubing, bulk 500'
68-3700-006	1/4" Vinyl tubing coupler
68-3700-007	3/8" Vinyl tubing coupler

**Power Sources**

60-1684-088	Model 913 High Capacity Power Pack (120-volt)
60-3004-130	Model 914 Battery-Backed Power Pack (120-volt)
60-1684-093	Model 923 High Capacity Power Pack (240-volt)
60-3004-160	Model 924 Battery-Backed Power Pack (240-volt)
60-1684-040	Model 934 Nickel-Cadmium Battery
60-3004-106	Model 946 Lead-Acid Battery
60-3004-059	Model 961 Battery Charger (120-volt)
68-3000-965	Model 965 Five Station Battery Charger
60-1394-023	Connect cable, for external 12 VDC power source; terminates in heavy duty battery clips

**Connect Cables and Interfaces**

60-1644-000	Model 1640 Liquid Level Actuator
60-3004-107	Connect cable, 25', Isco sampler to Isco flow meter
68-1680-060	Connector only, without cable, for use with non-Isco flow meters having an isolated contact closure proportional to flow
60-1394-077	Same as above, with 22' cable terminating in two wires
60-1784-007	Type A Interface (converts pulse duration flow proportional signal into pulses acceptable to Isco samplers)
60-3704-037	4-20 mA Sampler Input Interface (converts analog signal flow meter output as specified by user into pulses acceptable to Isco samplers)
60-2954-021	Software Upgrade Cable, PC-to-GLS

## **Pressurized lines**

The sampler can obtain samples from pressurized lines, as long as the line pressure does not exceed 15 psi (pounds per square inch). Pressures greater than 15 psi may prevent the sampler from purging the suction line; moreover, extreme pressures can force liquid past the pump, even when the pump is not running.

Isco does not recommend sampling from pressurized lines.

# Index

## A

About Isco .....	11
About the GLS documentation .....	6
Accessories .....	69
Attaching the strainer .....	18

## B

Batteries .....	16
Bottle installation .....	15
Bottle volume .....	30
Button descriptions .....	24

## C

Calibrate .....	34
Calibrating sample volumes .....	36
CE Declaration of Conformity .....	10
Cleaning .....	51
bottles .....	51
GLS .....	51
protocols for priority pollutants .....	52
tubing .....	51
Compatible equipment .....	9
Connecting external devices .....	20
Connecting the suction line .....	19
Contacting Isco for assistance .....	60
Continuous sampling mode .....	31
Cooling samples .....	15
Counting down delay times .....	41
Cutting suction line .....	17

## D

Date - setting .....	35
Debris deflector .....	17
Default program .....	27
Delay to first sample .....	33
Desiccant .....	56
renewing .....	58
replacing .....	56
Diagnostics .....	59
Discharge tube .....	55
inspecting .....	14
replacing .....	55
Display .....	24

## E

Errors .....	48
Event log .....	47



Event mark.....	44
External devices .....	20
<b>F</b>	
Flash updates.....	68
Flow meters and loggers.....	20
Foreign language displays .....	67
<b>G</b>	
Grab samples .....	49
<b>H</b>	
History of sample events.....	47
Humidity indicator .....	57
<b>I</b>	
Ice.....	15
Identifying GLS components .....	8
Inhibit .....	42
Input power .....	16
Inspecting the pump tube.....	13
Installing a bottle .....	15
Installing a power source .....	16
Interface non-Isco devices .....	20
Interval between samples .....	29
<b>K</b>	
Keypad.....	24
<b>L</b>	
Liquid detector disable.....	63
Liquid level actuator.....	20
Locking the GLS.....	22
Log.....	47
<b>M</b>	
Manual samples .....	49
<b>N</b>	
Number of samples .....	31
<b>O</b>	
One-button programming.....	27
Operating states .....	25
Options.....	63
foreign language displays.....	67
liquid detector disable .....	63
program lock.....	65
program storage.....	63
<b>P</b>	
Pacing.....	29
Pacing interval.....	29

Parameter Actuator Logger (PAL).....	20
Password protection .....	65
Pausing or stopping a program.....	45
Positioning the GLS.....	21
Post-purge.....	44
Post-sampling activities .....	45
Power.....	16
Power packs.....	16
Preparing the full sample bottle.....	46
Preparing the GLS.....	12
attaching the strainer.....	18
connecting external devices .....	20
connecting the suction line .....	19
cooling samples .....	15
discharge tube .....	14
inspect the pump tube .....	13
Install the bottle.....	15
installing a power source.....	16
positioning the GLS.....	21
Pre-purge .....	44
Product description .....	7
Program completion .....	45
Program lock.....	65
Program storage.....	63
Programming.....	26
bottle volume .....	30
calibrating sample volumes .....	34
delay to first sample .....	33
number of samples.....	31
one-button .....	27
pacing.....	29
pacing interval.....	29
sample volume.....	32
saving the program .....	63
standard programming .....	28
stored program .....	27
user interface .....	23
Pump tube.....	13
inspecting .....	13
replacing.....	53
warning.....	13

## R

Radio Interference Statement.....	10
Recapitulatif des mesures de securite.....	5
Recovering the sampler.....	46
Renewing the desiccant.....	58
Replacement parts .....	61
Replacing the discharge tube.....	55
Replacing the internal desiccant .....	56
Replacing the pump tube.....	53
Reports .....	47
Return instructions.....	61
Run state displays .....	43

## S

Safety summary .....	4
Sample collection cycle .....	44
Sample cooling.....	15
Sample volume.....	32
Sampler inhibit .....	42
Sampler pacing .....	29
Save.....	63
Schematic .....	62
Security .....	22
physical .....	22
software .....	65
Self-diagnostics .....	59
Service .....	50
cleaning .....	51
contacting Isco.....	60
desiccant .....	56
diagnostics.....	59
discharge tube .....	55
power sources.....	55
pump tube.....	53, 54
replacement parts .....	61
Setting the time and date.....	35
Site selection.....	21
Standard programming.....	28
Starting a program.....	41
States of operation .....	25
Stopping a program.....	45
Stored program .....	27
Storing a program.....	63
Strainer .....	17
attaching.....	18
maximum depths.....	21
positioning .....	21
Suction line.....	17
connecting .....	19
cutting.....	17
routing .....	21

## T

Technical specifications.....	10
Time - setting .....	35
Troubleshooting.....	59
Typical applications .....	9

## U

User interface.....	23
---------------------	----

## W

Warning change pump tube.....	13
Warranty .....	10
Welcome.....	4



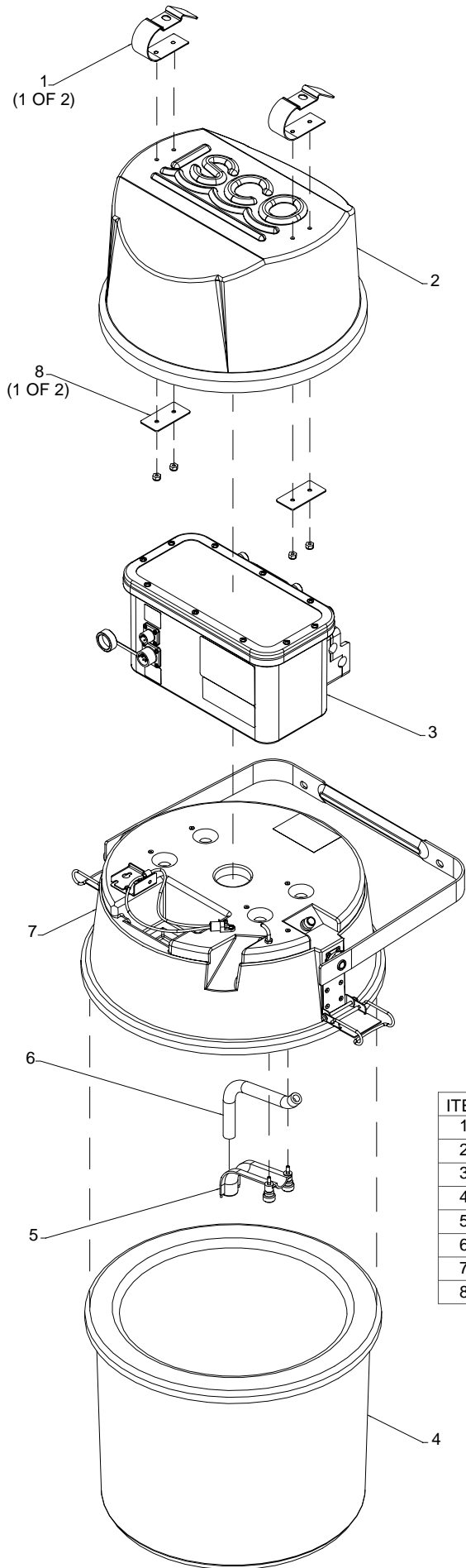

ITEM	INVENTORY NO.	DESCRIPTION
1	602954022	HANDLE LATCH ASSEMBLY
2	602954018	TOP COVER ASSEMBLY (INCLUDES ITEMS 1 & 8)
3	602954001	GLS SAMPLER CONTROLLER
4	602914010	BASE ASSEMBLY
5	602954029	TUBE GUIDE ASSEMBLY
6	602953032	GLS DISCHARGE TUBE, 8.25 INCH
7	602954031	CENTER SECTION ASSEMBLY
8	602953022	HANDLE LATCH BACKUP PLATE

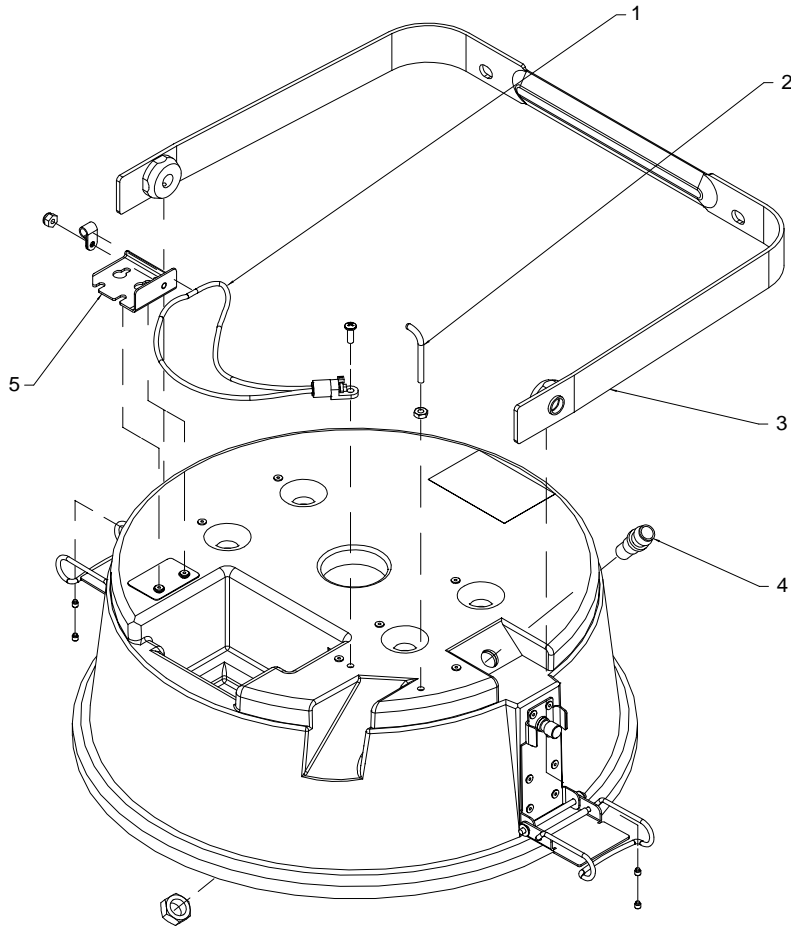

ITEM	INVENTORY NO.	DESCRIPTION
1	602954034	BATTERY HOLD-DOWN CORD
2	602953028	RETAINING HOOK
3	602954023	GLS HANDLE ASSEMBLY
4	602953039	TUBE BULK HEAD FITTING
5	602954026	BATTERY HOLD-DOWN ASSEMBLY

ITEM	INVENTORY NO	DESCRIPTION
1	692953011	TRIM RING
2	602954005	CONTROL PANEL ASSEMBLY (ITEMS 3, 4, 33 & 34)
3	602954007	KEYBOARD PCB ASSEMBLY
4	602954006	CPU PCB ASSEMBLY
5	602903011	CONTROL BOX GASKET
6	602953017	INTERCONNECT STRAP
7	602954003	PUMP GEAR ASSEMBLY
8	692953016	CONNECTOR LABEL (2 PER SHEET)
9	602954015	POWER CONNECTOR WIRING HARNESS
10	603113024	MEDIUM CONNECTOR PROTECTOR CAP
11	603113032	MEDIUM CONNECTOR CAP GASKET
12	609003291	CONNECTOR CAP STRAP
13	602954016	FLOW METER CONNECTOR WIRING HARNESS
14	601393082	AMP 2-PIN SEAL GASKET
15	601473057	AMP 6-PIN SEAL GASKET
16	602903121	BACK PLATE GASKET
17	602954013	CONNECTOR BACKING PLATE ASSEMBLY
18	202999903	LIP SEAL, 3/4" BORE, 3/8" SHAFT
19	603704019	INSIDE PUMP HOUSING ASSEMBLY (INCLUDES ITEMS 18, 20 & 27)
20	603703012	PUMP HOUSING BUSHING
21	602704019	PUMP ROTOR ASSEMBLY
22	603703278	PUMP HOUSING BUSHING
23	603704017	OUTSIDE PUMP HOUSING ASSEMBLY (INCLUDES ITEM 22)
24	602954030	GLS PUMP TUBE ASSEMBLY
25	603704021	DETECTOR LID ASSEMBLY
26	603704022	DETECTOR BASE ASSEMBLY
27	692953037	LABEL, PUMP CAUTION
28	602954002	CONTROL BOX MOD ASSEMBLY
29	692593018	2-7/8" X 2-5/16" X 4" BOX
30	099000208	4 OZ DESICCANT BAG
31	090355200	DUAL LOCK VELCRO FASTENER 1" WIDE X 1-1/4" LONG
32	090355100	DUAL LOCK VELCRO FASTENER 1" WIDE X 1-1/4" LONG
33	209902138	∅.375 ACETAL TENSION CLIP
34	490001300	HUMIDITY INDICATOR CARD

602953043.DRW

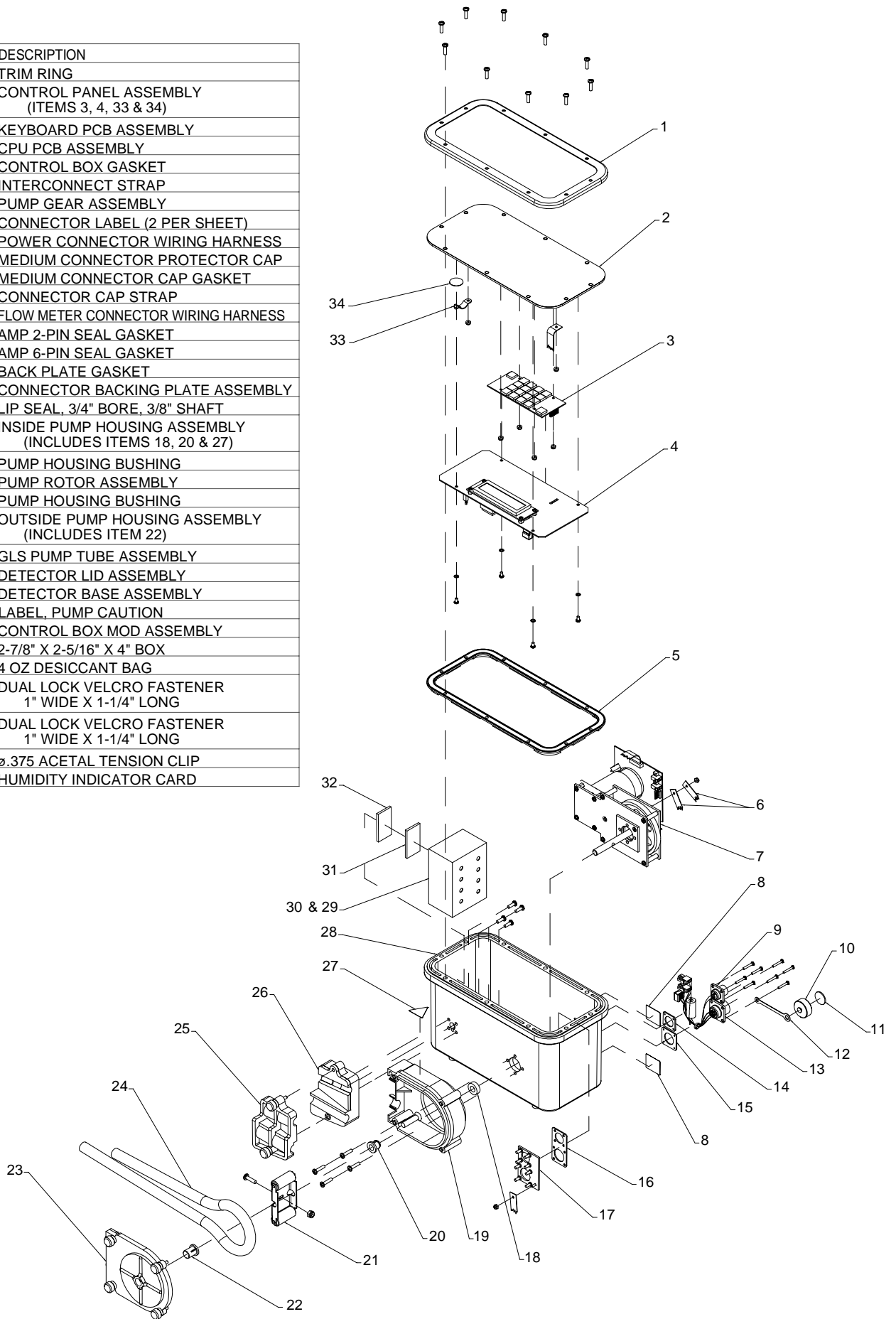

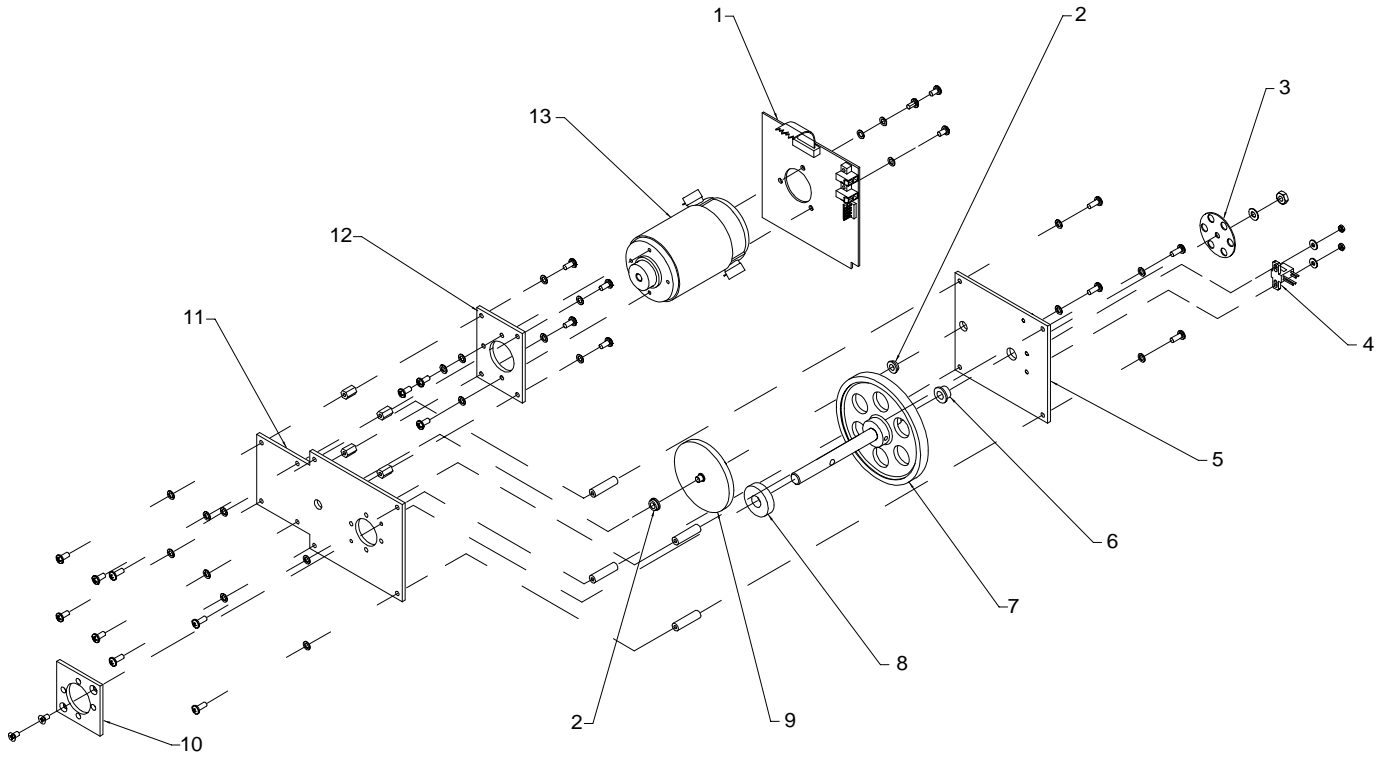

ITEM	INVENTORY NO.	DESCRIPTION
1	602954008	MOTOR DRIVER PCB ASSEMBLY
2	201311200	FLANGED BRONZE BEARING
3	609003112	PUMP SHAFT OPTICAL DISK
4	609004203	PUMP SENSOR CE WIRING ASSEMBLY
5	602954012	PUMP GEAR TRAIN TOP PLATE ASSEMBLY
6	201312300	FLANGED BRONZE BEARING .252 ID
7	602954011	PUMP SHAFT ASSEMBLY
8	602953012	PUMP SHAFT SPACER
9	602954010	COMBINATION GEAR ASSEMBLY
10	602703037	PUMP SHAFT SPACER PLATE
11	602953010	PUMP GEAR TRAIN BOTTOM PLATE
12	602953009	PUMP MOTOR PLATE
13	602954009	PUMP MOTOR ASSEMBLY

6029530043.DRW



REVISIONS					
CHG	AUTHORITY	DESCRIPTION	BY	CHKD	DATE
A	8785	MINOR CIRCUIT REVISIONS	TPW		98209
B	8794-2	RMV R25 CHG C31 ADD CR5	TPW		98236

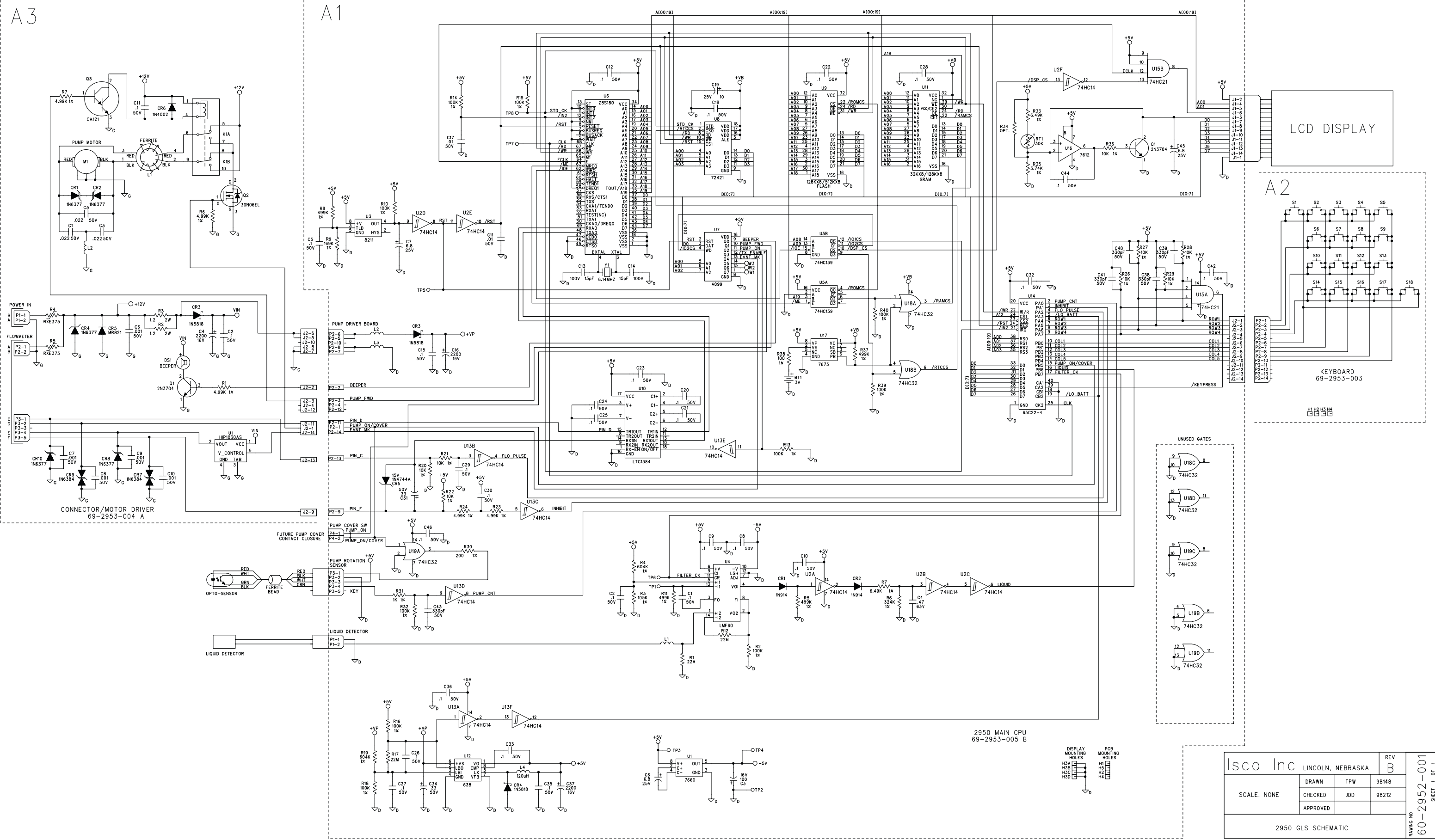

Isco Inc LINCOLN, NEBRASKA		REV	B
SCALE: NONE	DRAWN TPW	98148	
	CHECKED JDD	98212	
	APPROVED		
2950 GLS SCHEMATIC			

DRAWING NO 60-2952-001 SHEET 1 OF 1

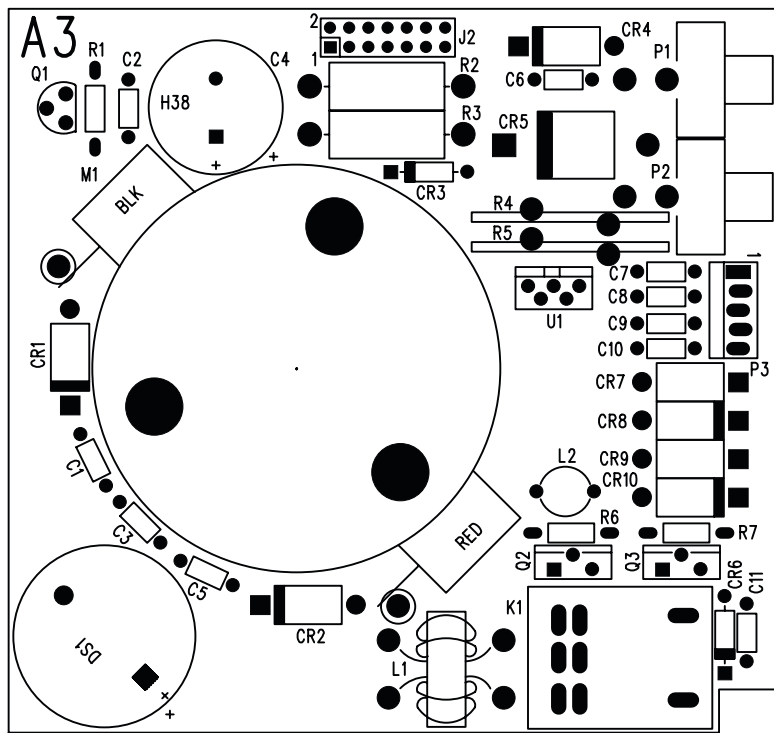

<b>Isco, Inc</b> LINCOLN, NEBRASKA		REV A	DRAWING NO 69-2953-004
<b>TOLERANCES</b> .X = +/- .1" .XX = +/- .02" .XXX = +/- .010"	DRAWN	TPW	98153
	CHECKED	JEF	98253
	APPROVED	F.NABITY	98253
2950 CONNECTOR/MOTOR DRIVE CIRCUIT BOARD			SHEET 2 OF 8
SILKSCREEN DWG			

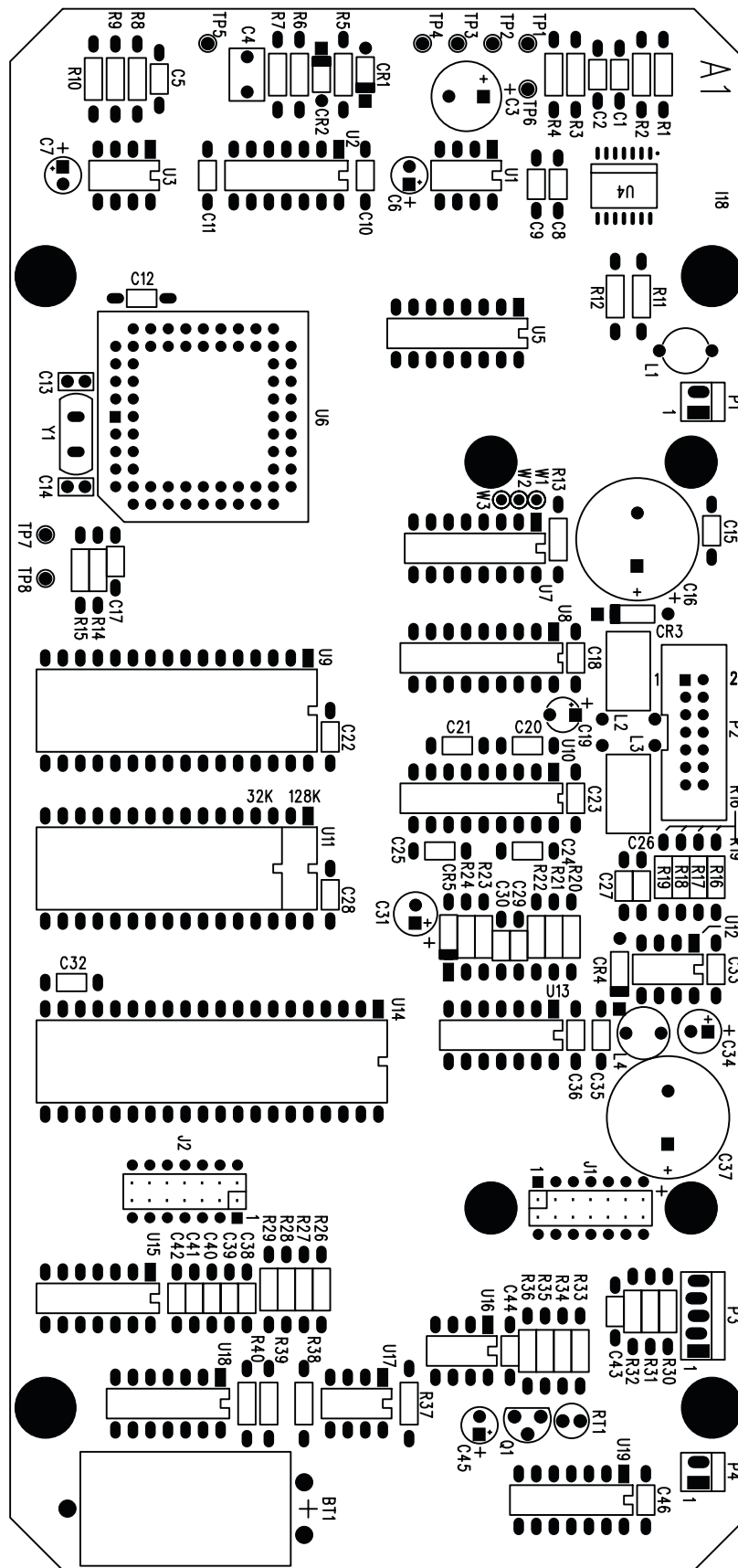

<b>Isco, Inc</b> LINCOLN, NEBRASKA		REV B	DRAWING NO 69-2953-005
<b>TOLERANCES</b> .X = +/- .1" .XX = +/- .02" .XXX = +/- .010"	DRAWN	TPW	98159
	CHECKED	JDD	98212
	APPROVED	F.NABITY	98252
2950 MAIN CPU CIRCUIT BOARD			SHEET 2 OF 8
SILKSCREEN DWG			

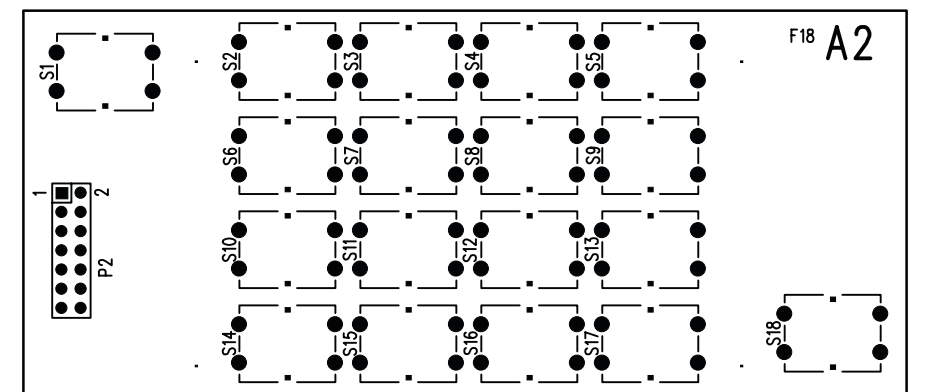

<b>Isco, Inc</b> LINCOLN, NEBRASKA		REV	DRAWING NO 69-2953-003
<b>TOLERANCES</b> .X = +/- .1" .XX = +/- .02" .XXX = +/- .010"	DRAWN	TPW	98159
	CHECKED		
	APPROVED		
2950 KEYBOARD CIRCUIT BOARD			SHEET 2 OF 6
SILKSCREEN DWG			

# Material Safety Data Sheets

Code: J96001  
 Date: 23 DEC 1993  
 Printed: 05 JAN 1994

## ENGELHARD MATERIAL SAFETY DATA SHEET

Product: DESICCITE<sup>(R)</sup> 25

### SECTION I: CHEMICAL PRODUCT AND COMPANY IDENTIFICATION

Common Name : BENTONITE, HEAT ACTIVATED GRANULES  
 Chemical Name : BENTONITE, HEAT ACTIVATED GRANULES  
 Formula : MONTMORILLONITE CLAY  
 Product CAS No.: 1302-78-9  
 Product Use : Drying agent

Supplier : ENGELHARD CORPORATION, CHEMICAL CATALYSTS GROUP  
 Address : 600 E. MCDOWELL ROAD  
 City, St, Zip : JACKSON, MS 39204  
 Phone : 1-800-458-8650 OR 1-800-654-4039

FOR CHEMICAL EMERGENCY CALL CHEMTREC (24 HOURS):  
 1-800-424-9300 (US, Canada, Puerto Rico, Virgin Islands)  
 1-202-483-7616 (Outside Above Area)

### SECTION II: COMPOSITION/INFORMATION ON INGREDIENTS

INGREDIENT	CAS NO.	% Wt.
SILICA, CRYSTALLINE (QUARTZ)	14808-60-7	1-3
ALUMINUM SILICATE	12141-46-7	97

#### INGREDIENT NOTES

NOTE: Industrial hygiene sampling in our plant has shown the respirable fraction of crystalline silica quartz to be only 0.1-0.115%.

NOTE: See Section VIII for Exposure Limits and Section XI for Toxicological Information.

# ISCO GLS SAMPLER

ENGELHARD  
MATERIAL SAFETY DATA SHEET

Page 2

Code: J96001  
Date: 23 DEC 1993

## SECTION III: HAZARDS IDENTIFICATION

### EMERGENCY OVERVIEW

Grey to off-white granules

Odorless

Flash Point: Not Applicable

SUSPECT CANCER HAZARD - Risk of cancer depends on route, duration and level of exposure.

Prolonged or repeated inhalation may cause lung damage.

May cause eye and respiratory tract irritation.

Not a fire or explosion hazard.

### ROUTES OF ENTRY

Eyes? NO

Skin? NO

Inhalation? YES

Ingestion? NO

### POTENTIAL HEALTH EFFECTS

EYE CONTACT may cause mechanical irritation if exposed to large amounts of dust.

SKIN CONTACT may cause irritation due to mechanical abrasion.

INHALATION causes irritation of the respiratory tract and may cause disabling, progressive pulmonary fibrosis (silicosis) due to CRYSTALLINE SILICA (QUARTZ). Symptoms include cough, dyspnea, wheezing, and impairment of pulmonary function. Progression of symptoms can continue after dust exposure ceases.

INGESTION: No adverse effects expected.

### CARCINOGENICITY

NTP? YES

IARC? YES

OSHA? NO

CRYSTALLINE SILICA is listed by the National Toxicology Program (NTP) as a confirmed animal carcinogen, and by the International Agency for Research on Cancer (IARC) as a Group 2A: sufficient evidence of carcinogenicity in laboratory animals and limited evidence in humans.

### CHRONIC HEALTH HAZARDS

Refer to Potential Health Effects and Carcinogenicity.

# ISCO GLS SAMPLER

ENGELHARD  
MATERIAL SAFETY DATA SHEET

Page 3

Code: J96001  
Date: 23 DEC 1993

## MEDICAL CONDITIONS GENERALLY AGGRAVATED BY EXPOSURE

May aggravate existing medical conditions such as respiratory ailments.

NOTE: See Section VIII for Exposure Limits, Section XI for Toxicological Information and Section XII for Ecological Information.

## SECTION IV: FIRST AID MEASURES

EYE CONTACT: Flush eyes with plenty of water. If irritation develops, call a physician.

SKIN CONTACT: Procedures normally not needed. If skin contact occurs flush with plenty of water. If irritation develops, call a physician.

INHALATION: Remove to fresh air. If breathing is difficult, give oxygen. Call a physician.

INGESTION: Procedures normally not needed. If large quantities are ingested, seek medical advice.

## SECTION V: FIRE-FIGHTING MEASURES

Flash Point: Not Applicable  
Auto-Ignition: Not Determined  
LEL: Not Determined  
UEL: Not Determined

### NFPA HAZARD CLASSIFICATION

Health: 0                      Flammable: 0                      Reactivity: 0

### HMIS HAZARD CLASSIFICATION

Health: 1\*                      Flammable: 0                      Reactivity: 0

\* Indicates the possibility of chronic health effects. See Chronic Health Hazards in Section III for more information.

### EXTINGUISHING MEDIA

Use water, carbon dioxide or foam.

### SPECIAL FIRE FIGHTING PROCEDURES

Wear positive-pressure self-contained breathing apparatus in fire conditions.

# ISCO GLS SAMPLER

ENGELHARD  
MATERIAL SAFETY DATA SHEET

Page 4

Code: J96001  
Date: 23 DEC 1993

## UNUSUAL FIRE AND EXPLOSION HAZARDS

Not a fire or explosion hazard.

### SECTION VI: ACCIDENTAL RELEASE MEASURES

Contain spillage and scoop up or vacuum. Avoid dusting.

**\*\*NOTE\*\*** In the event of an accidental release of this material, the above procedures should be followed. Additionally proper exposure controls and personal protection equipment should be used (see Section VIII - Exposure Control/Personal Protection) and disposal of the material should be in accordance with Section XI - Disposal Considerations.

### SECTION VII: HANDLING AND STORAGE

Use dustless systems for handling, storage, and clean up so that airborne dust does not exceed the PEL. Use adequate ventilation and dust collection. Practice good housekeeping. Do not permit dust to collect on walls, floors, sills, ledges, machinery, or equipment. Maintain, clean, and fit test respirators in accordance with OSHA regulations. Maintain and test ventilation and dust collection equipment. Wash or vacuum clothing which has become dusty. Product becomes slippery when wet.

Avoid breathing dust.

Avoid contact with eyes.

Use only with adequate ventilation.

### SECTION VIII: EXPOSURE CONTROLS/PERSONAL PROTECTION

#### EXPOSURE LIMITS

#### INGREDIENT

#### PEL-OSHA

#### TLV-ACGIH

SILICA, CRYSTALLINE (QUARTZ)

CAS NO.: 14808-60-7

0.1 mg/m<sup>3</sup>  
(Respirable dust)

0.1 mg/m<sup>3</sup>  
(Respirable dust)

ALUMINUM SILICATE

CAS NO.: 12141-46-7

15 mg/m<sup>3</sup> (as Al,  
dust)  
5 mg/m<sup>3</sup> (as Al,  
respirable  
fraction)

10 mg/m<sup>3</sup> (as Al,  
dust)

# ISCO GLS SAMPLER

ENGELHARD  
MATERIAL SAFETY DATA SHEET

Page 5

Code: J96001  
Date: 23 DEC 1993

Unless otherwise noted, all values are reported as 8-hour Time-Weighted Averages (TWAs) and total dust (particulates only). All ACGIH TLVs refer to the 1992-93 Standards. All OSHA PELs refer to 29 CFR Part 1910 Air Contaminants: Final Rule, January 19, 1989.

NOTE: As a result of the July 7, 1992 decision by the U.S. Circuit Court of Appeals (AFL-CIO v. OSHA) to vacate the 1989 PELs, OSHA will no longer enforce these new limits and will return to the pre-1989 PELs. Engelhard, however, will continue to list the more protective 1989 levels.

## RESPIRATORY PROTECTION

A NIOSH/MSHA-approved respirator is recommended if dust is generated.

## VENTILATION

General; local exhaust ventilation as necessary to control any air contaminants to within their PELs or TLVs during the use of this product.

## PROTECTIVE EQUIPMENT

Safety glasses (with side shields).

## PERSONNEL SAMPLING PROCEDURE

For CRYSTALLINE SILICA: Refer to NIOSH Manual of Analytical Methods, 3<sup>RD</sup> Edition, Volume 2, Methods 7500, 7601 and 7602.

## SECTION IX: PHYSICAL AND CHEMICAL PROPERTIES

Boiling Point: Not Applicable  
Specific Gravity (H<sub>2</sub>O=1): 2.0  
Melting Point: Not Applicable  
Vapor Pressure (mm Hg): Not Applicable  
Vapor Density (Air=1): Not Applicable  
Evap  
% Solubility In Water: Negli  
Appearance: Grey to off-white granules  
Odor: Odorless  
pH: Not Determined

## SECTION X: STABILITY AND REACTIVITY

Stability: Generally considered stable.  
Avoid: None expected.

# ISCO GLS SAMPLER

ENGELHARD  
MATERIAL SAFETY DATA SHEET

Page 6

Code: J96001  
Date: 23 DEC 1993

## INCOMPATIBILITY (Materials to Avoid)

None expected.

## HAZARDOUS DECOMPOSITION OR BY-PRODUCTS

None expected.

**Polymerization:** Polymerization is not expected to occur.

**Avoid:** Not applicable.

## SECTION XI: TOXICOLOGICAL INFORMATION

CHEMICAL NAME	% Wt.	LD50	LC50
SILICA, CRYSTALLINE (QUARTZ) CAS NO.: 14808-60-7	1-3	Not Available	Not Available
ALUMINUM SILICATE CAS NO.: 12141-46-7	97	Not Available	Not Available

NOTE: See Sections III, VIII and XII for additional information.

## SECTION XII: ECOLOGICAL INFORMATION

### ECOTOXICITY

No data available.

### ENVIRONMENTAL FATE

No data available.

## SECTION XIII: DISPOSAL CONSIDERATIONS

US EPA Waste Number: Not Regulated

Federal, state and local disposal laws and regulations will determine the proper waste disposal/recycling/reclamation procedures.

**\*\*NOTE\*\*** Chemical additions, processing or otherwise altering this material may make the waste management information presented above incomplete, inaccurate or otherwise inappropriate.

As local regulations may vary; all waste must be disposed/recycled/reclaimed in accordance with federal, state, and local environmental control regulations.



ISCO GLS SAMPLER

ENGELHARD  
MATERIAL SAFETY DATA SHEET

Page 7

Code: J96001  
Date: 23 DEC 1993

SECTION XIV: TRANSPORT INFORMATION

INTERNATIONAL

UN Number: Not Regulated

UNITED STATES

EPA Waste Number: Not Regulated  
DOT Classification: Not Regulated

CANADA

PIN Number: Not Regulated  
TDG Class: Not Regulated

EC

DGL: Not Regulated

SECTION XV: REGULATORY INFORMATION

US FEDERAL REGULATIONS

TSCA: IN TSCA

SARA 311 AND 312 HAZARD CATEGORIES

IMMEDIATE (Acute) Health Hazard: NO  
DELAYED (Chronic) Health Hazard: YES  
FIRE Hazard: NO  
REACTIVITY Hazard: NO  
Sudden Release of PRESSURE: NO

SARA SECTION 313 NOTIFICATION

This product does not contain toxic chemicals subject to the reporting requirements of Section 313 of Title III of the Superfund Amendments and Reauthorization Act of 1986 and 40 CFR Part 372.

OZONE DEPLETING SUBSTANCES (ODS)

This product neither contains nor is manufactured with an ozone depleting substance subject to the labelling requiremehe Clean -⊕

VOLATILE ORGANIC COMPOUNDS (VOC)

Not Determined

# ISCO GLS SAMPLER

ENGELHARD  
MATERIAL SAFETY DATA SHEET

Page 8

Code: J96001  
Date: 23 DEC 1993

## US STATE REGULATIONS

CALIFORNIA: The State of California has a regulation (Proposition 65) which identifies specific chemicals known to the State of California to cause cancer or birth defects. Proposition 65 requires a disclosure for products sold within the State of California containing an identified chemical. The following information is required by the State of California for this product:

\*This product contains chemicals known to the State of California to cause cancer.

VOLATILE ORGANIC COMPOUND (CARB): Not Determined

## CANADIAN REGULATIONS

DSL/NDSL: DSL  
WHMIS Classification: Class D Division 2 Subdivision A

## EUROPEAN REGULATIONS

EINECS: Yes

## OTHER REGULATIONS

MITI: Yes

AICS: Yes

SECTION XVI: OTHER INFORMATION
--------------------------------

## REVISIONS

Revision Number: 10

This MSDS has been revised in the following section(s):

SECTION II: COMPOSITION/INFORMATION ON INGREDIENTS  
SECTION VIII: EXPOSURE CONTROLS/PERSONAL PROTECTION  
SECTION IX: PHYSICAL AND CHEMICAL PROPERTIES  
SECTION XV: REGULATORY INFORMATION

## PREPARATION INFORMATION

Prepared By: Corporate Environment, Health & Safety Group  
Phone Number: See Section I

---

The information in this Material Safety Data Sheet should be provided to all who will use, handle, store, transport, or otherwise be exposed to this product. This information has been prepared for the guidance of plant engineering, operations, and management and for persons working

## ISCO GLS SAMPLER

ENGELHARD  
MATERIAL SAFETY DATA SHEET

Page 9

Code: J96001  
Date: 23 DEC 1993

with or handling this product. The information presented in the MSDS is premised upon proper handling and anticipated uses and is for the material without chemical additions/alterations. We believe this information to be reliable and up-to-date as of the date of publication, but make no warranty that it is. Additionally, if this Material Safety Data Sheet is more than three years old, please contact the supplier at the phone number listed in Section I to make certain that this sheet is current. Copyright Engelhard Corporation. License granted to make unlimited copies for internal use only. End of MSDS.....

# ISCO GLS SAMPLER



UNITED DESICCANTS

United Catalysts Inc.  
Desiccants Division

101 Christine Drive  
Rio Grande Industrial Park  
Belen, NM 87002  
Telephone: 505-864-6691  
Fax: 505-864-9296

MATERIAL SAFETY DATA SHEET  
DESI PAK  
Packaged Desiccant

---

## SECTION I PRODUCT IDENTIFICATION

---

Trade Name and Synonyms: DESI PAK

Chemical Family: Clay Mineral

Chemical Names & Synonyms: Montmorillonite Clay Mineral  
Smectite Clay Mineral  
Bentonite  
Calcium Aluminosilicate

Formula:  $(Ca)_x(Al_{2-x}Mg_x)Si_4O_{10}(OH)_2 \cdot nH_2O$

NFPA/HMIS: HEALTH - 0, FIRE - 0, REACTIVITY - 0, SPECIFIC HAZARD -  
SEE SECTION X

---

## SECTION II HAZARDOUS INGREDIENTS

---

Hazardous Components in the Solid Mixture

<u>COMPONENT</u>	<u>CAS No.</u>	<u>%</u>	<u>OSHA/PEL</u>	<u>ACGIH/TLV</u>
Montmorillonite Clay Mineral Respirable Dust	1302-78-9	≥ 99	5.0 mg/m <sup>3</sup>	5.0 mg/m <sup>3</sup>
Silicon dioxide (Crystalline Quartz) Respirable Dust	14808-60-7	≤ 1	0.1 mg/m <sup>3</sup>	0.1 mg/m <sup>3</sup>

INGREDIENT HAZARD STATEMENT - Risk of cancer depends on duration and level of exposure. This product contains less or equal to 1% crystalline quartz (CAS #14808-60-7). The quartz contained in the material is in granular form and packed in bags for use as a desiccant. Therefore, no exposure to quartz dust is anticipated under normal use of this product. Avoid inhaling desiccant dust.

Prolonged or repeated exposure may cause lung injury. Unless otherwise noted, all values are reported as 8-hour Time Weighted Averages (TWA's) and total dust (particulates only). All ACGIH TLV's refer to the 1989-90 Standards. All OSHA PEL's refer to CFR Part 1910 Air Contaminants: Final Rule, January 19, 1989.

Updated: April 4, 1994

Page 1

# ISCO GLS SAMPLER

## MATERIAL SAFETY DATA SHEET DESI PAK Packaged Desiccant

---

### SECTION III PHYSICAL DATA

---

Appearance and Odor: Gray granules. No odor.

Melting Point: N/A

Solubility in Water: Insoluble.

Bulk Density: 57-64 lbs./cu. ft.

Percent Volatile by Weight at 150 deg C: < 3.0 %.

---

### SECTION IV FIRE EXPLOSION DATA

---

Fire and Explosion Hazard - Negligible fire and explosion hazard when exposed to heat or flame by reaction with incompatible substances.

Flash Point - Nonflammable.

Firefighting Media - Dry chemical, water spray, or foam. For larger fires, use water spray fog or foam.

Firefighting - Nonflammable solids, liquids or gases: Cool containers that are exposed to flames with water from the side until well after fire is out. For massive fire in enclosed area, use unmanned hose holder or monitor nozzles; if this is impossible, withdraw from area and let fire burn. Withdraw immediately in case of rising sound from venting safety device or any discoloration of the tank due to fire.

---

### SECTION V HEALTH HAZARD DATA

---

This material is normally packaged and contained in a bag. If the bag is open, the resulting dust is classified a nuisance dust, and may cause health hazards when inhaled, ingested or in contact with the eyes and skin. Prolonged inhalation may cause irritation to the upper respiratory tract and/or lung damage. If large amounts are ingested, intestinal disorders may occur. Contact with eye tissue may result in irritation. Prolonged or repeated contact with the skin in the absence of proper hygiene may cause irritation.

DESI PAK clay may contain a small amount of crystalline silica (quartz). Inhalation of crystalline silica in the respirable range in excess of the TLV may result in an increase in the risk of serious respiratory disease. Avoid breathing the dust. Use NIOSH/MSHA approved respirators when the TLV for crystalline silica may be exceeded.

Updated: April 4, 1994

Page 2

# ISCO GLS SAMPLER

## MATERIAL SAFETY DATA SHEET DESI PAK Packaged Desiccant

Crystalline silica is listed by the International Agency for Research on Cancer (IARC) as a 2A: sufficient evidence in laboratory animals and limited evidence of carcinogenicity in humans.

### CARCINOGENICITY

NTP? NO

IARC? YES

OSHA? NO

**First Aid (Inhalation)** - Remove to fresh air immediately. If breathing has stopped, give artificial respiration. Keep affected person warm and at rest. Get medical attention immediately.

**First Aid (Ingestion)** - If large amounts have been ingested, give emetics to cause vomiting. Stomach siphon may be applied as well. Milk and fatty acids should be avoided. Get medical attention immediately.

**First Aid (Eyes)** - Wash eyes immediately and carefully for 30 minutes with running water, lifting upper and lower eyelids occasionally. Get prompt medical attention.

**First Aid (Skin)** - To avoid repeated or prolonged contact with this chemical, use good hygienic practices. Wash with soap and a large amount of water. Get medical attention if irritation or inflammation develops.

---

### SECTION VI REACTIVITY DATA

---

**Reactivity** - Is stable under normal temperatures and pressures in sealed containers. Hazardous polymerization will not occur.

---

### SECTION VII SPILL OR LEAK PROCEDURES

---

Notify safety personnel of spills or leaks. Clean-up personnel need protection against inhalation of dusts or fumes. Eye protection is required. Vacuuming and/or wet methods of cleanup are preferred. Place in appropriate containers for disposal, keeping airborne particulates at a minimum. Clay is slippery when wet.

**Disposal** - Consult applicable local, state, and federal regulations to select the method of disposal. Recover metal components by reprocessing whenever possible.

Updated: April 4, 1994

Page 3

# ISCO GLS SAMPLER

## MATERIAL SAFETY DATA SHEET DESI PAK Packaged Desiccant

---

### SECTION VIII SPECIAL PROTECTION INFORMATION

---

**Respiratory Protection** - Provide a NIOSH/MSHA jointly approved respirator in the absence of proper environmental control. Contact your safety equipment supplier for proper mask type.

**Ventilation** - Provide general and/or local exhaust ventilation to keep exposures below the TLV. Ventilation used must be designed to prevent spots of dust accumulation or recycling of dusts.

**Protective Clothing** - Wear protective clothing, including long sleeves and gloves, to prevent repeated or prolonged skin contact.

**Eye Protection** - Chemical splash goggles designed in compliance with OSHA regulations are recommended. Consult your safety equipment supplier.

---

### SECTION IX STORAGE PRECAUTIONS

---

Store in a dry, well ventilated place, below 115 degrees F., away from a heat source. Keep in tightly closed container. Protect container from physical damage. Always reseal container and protective moisture barrier liner after use.

---

### SECTION X

---

HMIS (Hazardous Materials Identification System) for this product is as follows:

Health Hazard	0
Flammability	0
Reactivity	0
Personal Protection	HMIS assigns choice of personal protective equipment to the customer, as the raw material supplier is unfamiliar with the condition of use.

---

The information contained herein is based upon data considered true and accurate. However, United Desiccants makes no warranties expressed or implied, as to the accuracy or adequacy of the information contained herein or the results to be obtained from the use thereof. This information is offered solely for the user's consideration, investigation and verification. Since the use and conditions of use of this information and the material described herein are not within the control of United Desiccants, United Desiccants assumes no responsibility for injury to the user or third persons. The material described herein is sold only pursuant to United Desiccants' Terms and Conditions of Sale, including those limiting warranties and remedies contained therein. It is the responsibility of the user to determine whether any use of the data and information is in accordance with applicable federal, state or local laws and regulations.

\* No Information Available

Doc. 50

Updated: April 4, 1994

Page 4

# ISCO GLS SAMPLER

## Material Safety Data Sheet

Natrasorb M (Clay-Paper Pouch)

Identify (Trade Name as Used on Label)

<b>Manufacturer:</b> MULTISORB TECHNOLOGIES, INC. (formerly Multiform Desiccants, Inc.)	<b>MSDS Number* :</b>
<b>Address:</b> 325 Harlem Road Buffalo, NY 14224	<b>CAS Number* :</b>
<b>Phone Number (For Information):</b> 716/824-8900	<b>Date Prepared:</b> April 19, 1996
<b>Emergency Phone Number:</b> 716/824-8900	<b>Prepared By* :</b> G.E. McKedy

### Section 1 - Material Identification and Information

Components - Chemical Name & Common Names (Hazardous Components 1% or greater; Carcinogens 0.1% or greater)	%*	OSHA PEL	ACGIH TLV	OTHER LIMITS RECOMMENDED
Montmorillonite Clay	86-93	N/A	N/A	
Crystalline silica quartz	2-4	2mg/m <sup>3</sup> (respirable dust)	0.1 mg/m <sup>3</sup> (respirable dust)	
Non-Hazardous Ingredients    Paper	5-10			
<b>TOTAL</b>	<b>100</b>			

### Section 2 - Physical/Chemical Characteristics

<b>Boiling Point</b>	N/A	<b>Specific Gravity (H<sub>2</sub>O = 1)</b>	2.0 (Montmorillonite Clay)
<b>Vapor Pressure (mm Hg and Temperature)</b>	N/A	<b>Melting Point</b>	N/A
<b>Vapor Density (Air =1)</b>	N/A	<b>Evaporation Rate (=1)</b>	N/A
<b>Solubility in Water</b>	Not soluble, but will adsorb moisture.	<b>Water Reactive</b>	Not reactive, but will adsorb moisture.
<b>Appearance and Odor</b>	Paper pouch containing tan powder.		

### Section 3 - Fire and Explosion Hazard Data

<b>Flash Point and Methods Used</b>	N/A	<b>Auto-Ignition Temperature</b>	N/A	<b>Flammability Limits in Air % by Volume</b>	N/A	<b>LEL</b>	<b>UEL</b>
<b>Extinguisher Media</b>	Water is best extinguishing medium, but dry chemical, carbon dioxide and foam can be used.						
<b>Special Fire Fighting Procedures</b>	None. The paper pouch will burn, but the clay will not.						
<b>Unusual Fire and Explosion Hazards</b>	None.						

### Section 4 - Reactivity Hazard Data

<b>STABILITY</b> <input checked="" type="checkbox"/> Stable <input type="checkbox"/> Unstable	<b>Conditions To Avoid</b>	Moisture, clay will adsorb moisture.
<b>Incompatibility (Materials to Avoid)</b>	None.	
<b>Hazardous Decomposition Products</b>	Carbon dioxide, carbon monoxide, water	
<b>HAZARDOUS POLYMERIZATION</b> <input type="checkbox"/> May Occur <input checked="" type="checkbox"/> Will Not Occur	<b>Conditions To Avoid</b>	None



# ISCO GLS SAMPLER

## Section 5 - Health Hazard Data

<b>PRIMARY ROUTES OF ENTRY</b>	<input checked="" type="checkbox"/> Inhalation	<input checked="" type="checkbox"/> Ingestion	<b>CARCINOGEN LISTED IN</b>	<input type="checkbox"/> NTP	<input type="checkbox"/> OSHA
	<input checked="" type="checkbox"/> Skin Absorption	<input type="checkbox"/> Not Hazardous		<input type="checkbox"/> IARC Monograph	<input checked="" type="checkbox"/> Not Listed
<b>HEALTH HAZARDS</b>	Acute	May cause eye, skin and mucous membrane irritation.			
	Chronic	Prolonged inhalation may cause lung damage.			
<b>Signs and Symptoms of Exposure</b>	Drying and irritation.				
<b>Medical Conditions Generally Aggravated by Exposure</b>	Asthma				
<b>EMERGENCY FIRST AID PROCEDURES - Seek medical assistance for further treatment, observation and support if necessary.</b>					
<b>Eye Contact</b>	Flush with water for at least 15 minutes.				
<b>Skin Contact</b>	Wash affected area with soap and water.				
<b>Inhalation</b>	Remove affected person to fresh air.				
<b>Ingestion</b>	No adverse effects expected.				

## Section 6 - Control and Protective Measures

<b>Respiratory Protection (Specify Type)</b>	Use NIOSH approved dust respirator.				
<b>Protective Gloves</b>	Light cotton gloves.		<b>Eye Protection</b>	Safety glasses.	
<b>VENTILATION TO BE USED</b>	<input type="checkbox"/> Local Exhaust		<input type="checkbox"/> Mechanical (General)		<input type="checkbox"/> Special
	<input checked="" type="checkbox"/> Other (Specify) None.				
<b>Other Protective Clothing and Equipment</b>	None.				
<b>Hygienic Work Practices</b>	Avoid raising dust. Avoid contact with skin, eyes and clothing.				

## Section 7 - Precautions for Safe Handling and Use/Leak Procedures

<b>Steps to be Taken if Material Is Spilled Or Released</b>	Sweep or vacuum up the spilled material and place in a waste disposal container. Avoid raising dust.				
<b>Waste Disposal Methods</b>	Dispose in an approved landfill according to federal, state and local regulations.				
<b>Precautions to be Taken In Handling and Storage</b>	Cover promptly to avoid blowing dust. Wash after handling.				
<b>Other Precautions and/or Special Hazards</b>	Keep in sealed container away from moisture. Clay will readily adsorb moisture.				



# Isco GLS Compact, Lightweight Sampler



## *It's a Great Little Sampler!*

The GLS Sampler is especially designed for general purpose or priority pollutant sampling in municipal and industrial applications where a full-size sampler is too large. It is ideal for general purpose or toxic pollutant composite sampling. It collects composite samples – based on time or flow intervals – in 1- or 2.5-gallon glass or polyethylene bottles, or 2-gallon disposable ProPak bags. Up to 24 sampling stop and resume times can be preset for unattended, automatic sampling.



## ***Exclusive Quick-touch Operation***

With GLS's exclusive simplified programming, you can set up in less than a minute for:

- Uniform time intervals
- Flow-paced sampling with or without time delay

When finished, store your sampling routine as the default program.

Then, in the field, the operator simply calls up the program with two keystrokes, presses the green "go" button – and the sampling routine begins.

Of course, you always have the option of setting another routine in the field – without losing your default program. If you can press a button, you can operate the GLS. It's that easy!

## ***Ultra Compact***

Overall diameter is only 16.5 inches, so the GLS fits easily into manholes as small as 18 inches (45.7 cm), and also easily drops into most offset manholes.

## ***Easy to Handle***

With a dry weight of less than 25 lbs, GLS is the lightest sampler in the Isco line. A hinged handle makes one-handed carrying a breeze.

## ***Accurate, repeatable sample delivery***

The exclusive LD90 Liquid Presence Detector and patented\* Isco pump revolution counting system deliver accurate, repeatable sample volumes time after time. The system also provides a preconditioning rinse of the suction line to eliminate sample contamination.



*GLS takes the strain out of lifting and carrying.*

# Isco GLS Compact, Lightweight Sampler Specifications

Contact the factory or your Isco representative for additional specifications.

Sampler			Controller		
Height	26.5 in.	67.3 cm	Weight	8.0 lbs.	3.6 kg
Diameter	16.5 in.	41.9 cm	Dimensions	10 x 12.5 x 10 in.	26 x 32 x 25 cm
Weight (dry)	24.5 lbs.	11.1 kg	Operational Temperature	32° to 120°F	0° to 49°C
Sampler Base Capacity	1.0 or 2.5 gallon polyethylene or glass container.		Enclosure Rating	NEMA 4X, 6	IP67
Power Requirements	12 volts DC. (Supplied by battery or AC power converter.)		Program Memory	Non-volatile ROM	
Pump			Flow Meter	5 to 15 volt DC pulse or 25 millisecond isolated contact closure.	
Intake Purge	Purge before and after each sample.		Signal Requirements	Up to 500 samples. (Fail-safe float shutoff.)	
Tubing Life Indicator	Provides a warning to change pump tubing.		Number of Composite Samples to Shutoff	1 minute per month, typical	
Intake Suction Tubing Length	3 to 99 ft.	1 to 30 m	Software		
Material	Vinyl or Teflon® lined		Sample Frequency Selection	1 minute to 9,999 minutes, in 1 minute increments 1 to 9,999 flow pulses	
Inside Dimension	0.375 in. or 0.250 in.	1 cm or 0.6 cm	Sampling Modes	Uniform time flow. (Flow mode is controlled by external flow meter pulses.)	
Pump Tubing Life	Typically, 500,000 pump counts		Programmable Sample Volumes	10 to 9,990 ml in 1 ml increments	
Maximum Suction Lift	26 ft.	7.9 m	Program Storage	1 sampling program	
Typical Repeatability	±10 ml		Controller Diagnostics	Tests for RAM, ROM, and pump display	
Typical Line Transport Velocity at head heights of:					
3 ft. (0.9 m)	2.9 ft./s	0.88 m/s			
10 ft. (3.1 m)	2.5 ft./s	0.76 m/s			
15 ft. (4.6 m)	1.9 ft./s	0.58 m/s			
Liquid Presence Detector	Non-wetted, non-conductive sensor detects when liquid sample reaches the pump to automatically compensate for changes in head heights.				

© DuPont

## Ordering Information

Suction line, strainer, or additional ProPak bags not included; order separately. Contact the factory or your Isco representative for complete ordering information.

Description	Part Number
GLS Portable Composite Sampler with:	
2.5-gallon round polyethylene bottle	68-2950-001
2.5-gallon round glass bottle	68-2950-002
1-gallon round polyethylene bottle	68-2950-003
1-gallon round glass bottle	68-2950-004
2-gallon capacity ProPak system (includes 100 disposable bags)	68-2950-005



Shown here on a 23-inch manhole cover, the GLS Sampler is a compact 16.5 inches in diameter.



**Isco, Inc.**  
 4700 Superior St.  
 Lincoln, NE 68504 USA  
 Phone: (402) 464-0231  
 USA & Canada: (800) 228-4373  
 Fax: (402) 465-3022  
 E-Mail: info.ed@isco.com

**Isco Instruments AG**  
 Heckenweg 3  
 CH - 8704 Herrliberg  
 Switzerland  
 Phone: (41-1) 915 37 54  
 Fax: (41-1) 915 41 31

**NOTE:** for complete, detailed specifications, please consult the factory.

Isco is continually improving its products and reserves the right to change specifications without notice.

©1998 Isco, Inc. • Printed in U.S.A. • All rights reserved • #2123DSGLS • 9/98

# Manufacturer's CE Declaration of Conformity

**Manufacturer:** Isco, Inc.  
531 Westgate Blvd.  
PO Box 82531  
Lincoln, NE 68501 USA

**Description of Equipment:** Model 2950 GLS Sampler  
Accessory Equipment Model 923 Power Pack

**Operating Voltage:** GLS Sampler: 12 VDC  
Model 923 Power Pack: 230 VAC 50 HZ

**Council Directive(s):** 89/336/EEC Electromagnetic Compatibility Directive  
73/23/EEC Low Voltage Directive

**Year CE Mark Affixed:** 1998

**Standards Applied:** EN 55011:1991, Group 1, Class A - Limits and methods of measurement of radio disturbance characteristics of industrial, scientific, and medical radio-frequency equipment.

EN 50082-1:1992, Electromagnetic Compatibility - Generic immunity Part 1: Residential, commercial and light industry.

EN 61010-1:1993, Part 1 General requirements - Safety requirements for electrical equipment for measurement, control, and laboratory use.

**CE Marking**  
**Authorization by:** Bill Foster  
Isco Director of Engineering

Kurt Maring, European Contact  
Isco Instruments (Europe) AG  
Heckenweg 3  
CH-8704 Herrliberg,  
SWITZERLAND

We, the undersigned, hereby declare that the equipment specified above conforms with the applicable Directive(s) and listed Standard(s).

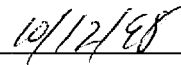
  
\_\_\_\_\_  
Bill Foster  
  
\_\_\_\_\_  
Date

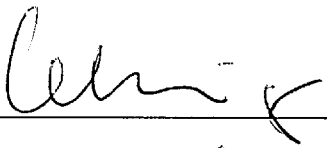
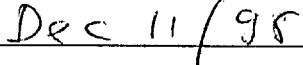
  
\_\_\_\_\_  
Kurt Maring  
  
\_\_\_\_\_  
Date



# One year, limited Warranty

*Please read before instrument setup.*

**ISCO INSTRUMENTS HAVE A ONE YEAR LIMITED WARRANTY COVERING BOTH PARTS AND LABOR.** Should any instrument become defective due to faulty parts or workmanship within the guarantee period, it will be repaired at the factory at no charge to the customer. Isco will pay **SURFACE** transportation charges both ways within the contiguous United States if the instrument proves to be defective **WITHIN 30 DAYS** from the date of shipment. Throughout the remainder of the guarantee period, the customer will pay transportation charges to return the defective instrument to Isco, and Isco will pay **SURFACE** transportation charges to return the repaired instrument to the customer. Isco will not pay air freight or packing and crating charges. The warranty period begins with the shipping date of the instrument to the original purchaser. All requests for warranty service must be received within the warranty period.

At the convenience of Isco, Isco may reimburse the customer to have the repairs performed

by a qualified technician in the customer's locality. Authorization must be granted prior to the time any repair is performed.

**ISCO'S EXCLUSIVE LIABILITY IS LIMITED TO REPAIR OR REPLACEMENT OF DEFECTIVE INSTRUMENTS. UNDER NO CIRCUMSTANCES IS ISCO LIABLE FOR CONSEQUENTIAL DAMAGES. THIS WARRANTY IS EXPRESSLY IN LIEU OF ALL OTHER WARRANTIES AND OBLIGATIONS AND ISCO SPECIFICALLY DISCLAIMS ANY WARRANTY OF MERCHANTABILITY OR FITNESS FOR A PARTICULAR PURPOSE.** The following are not covered by this warranty: Expendable items such as charts, pens, suction and pump tubing and glassware; damage due to corrosion, abuse, accident or alteration; and suitability for any specific purpose.

**OUTSIDE THE WARRANTY PERIOD, REPLACEMENT PARTS AND REPAIR LABOR ARE GUARANTEED FOR 90 DAYS.**

The warrantor is Isco, Inc., Lincoln, Nebraska, U.S.A.

## **INSTRUCTIONS FOR RETURNING INSTRUMENTS FOR REPAIR.**

Before returning any instrument for repair, call or write our service department for instructions. Simple difficulties can often be diagnosed over the phone.

Pack the instruments carefully, preferably in its original carton, and ship to the attention of the service department. U.P.S. or motor freight is generally the best method except for very small, non-fragile items which can be sent by insured parcel post. **BE SURE TO ENCLOSE A NOTE EXPLAINING THE DEFECT AND A PURCHASE ORDER AUTHORIZING THE REPAIR.**

### **Return equipment to:**

Isco, Inc.

531 Westgate Blvd.

Lincoln, NE 68528-1586, U.S.A.

**Mailing Address:** P.O. Box 82531, Lincoln, NE 68501, U.S.A.

**Phone:** (402) 464-0231 or (800) 775-2965 (U.S.A, Canada, and Mexico)

**FAX:** (402) 465-3085

The logo for ISCO, featuring the word "ISCO" in a bold, sans-serif font. Below the letters "S" and "C" is a stylized, wavy horizontal line that resembles a wave or a decorative underline. A registered trademark symbol (®) is located to the upper right of the "O".

June, 1995

